



This is the accepted manuscript made available via CHORUS. The article has been published as:

## Symmetry manipulation of nonlinear optical effect for metallic transition-metal dichalcogenides

Ren Habara and Katsunori Wakabayashi

Phys. Rev. B **107**, 115422 — Published 21 March 2023

DOI: [10.1103/PhysRevB.107.115422](https://doi.org/10.1103/PhysRevB.107.115422)

# Symmetry manipulation of nonlinear optical effect for metallic TMDC

Ren Habara<sup>1</sup> and Katsunori Wakabayashi<sup>1,2,3</sup>

<sup>1</sup>*Department of Nanotechnology for Sustainable Energy, School of Science and Technology, Kwansei Gakuin University, Gakuen-Uegahara 1, Sanda 669-1330, Japan*

<sup>2</sup>*National Institute for Materials Science (NIMS), Namiki 1-1, Tsukuba 305-0044, Japan*

<sup>3</sup>*Center for Spintronics Research Network (CSRN), Osaka University, Toyonaka 560-8531, Japan*  
(Dated: March 6, 2023)

Nonlinear optical (NLO) effect plays a crucial role to engineer optical angular frequency and symmetry of electronic system. Metallic transition-metal dichalcogenide (TMDC) is one of two-dimensional (2D) materials, which has no inversion symmetry for odd-number-layer. In particular, odd-number-layered NbSe<sub>2</sub> has spin splitting owing to Ising-type spin-orbit coupling. In this paper, we numerically calculate the NLO charge and spin conductivities of NbSe<sub>2</sub> based on an effective tight-binding model for several different optical effects, i.e., symmetry manipulation by bi-circular light (BCL) and bulk photovoltaic effect (shift and injection current). Under irradiation of BCL which can control the symmetry of electronic system, the current can be generated even in even-number-layered NbSe<sub>2</sub>. Also, we find that shift current can be generated for odd-number-layered NbSe<sub>2</sub>, which is robust against electronic scattering, i.e., topological current. The direction of generated shift current can be switched by altering polarization of light. Our results will serve to design opt-spintronics devices based on 2D materials to manipulate the charge and spin current and their directions by controlling the polarization of incident light which recasts the symmetry of electronic system.

## I. INTRODUCTION

Interaction of strong coherent light with matter advanced the field of nonlinear optics, which induces a charge polarization nonlinearly. The emergence of second-order nonlinear optical (NLO) effect has been extensively studied in condensed matter physics and materials science [1–4]. It provides the foundation of laser frequency conversion [5–21] and direct current (DC) photocurrent generation [22–31]. In the NLO process, the crystal symmetry is significant. If a crystal is centrosymmetric, no charge polarization occurs. In noncentrosymmetric crystal, however, nonlinear charge polarization is induced which can generate DC photocurrent without p-n junctions [22–31] and second-harmonic generation (SHG) [5–15].

Transition-metal dichalcogenide (TMDC) with the chemical formula MX<sub>2</sub> (M = Mo, W, Nb, Ta; X = S, Se) is layered materials, which can be easily exfoliated into monolayer due to weak van der Waals forces between layers of TMDC [32–36]. Thus, TMDC forms a new class of atomically thin two-dimensional (2D) electronic systems. For NLO response, the advantage of atomically-thin 2D materials such as graphene and TMDC is that the phase-matching conditions between incident light and light-induced electric polarization wave can be ignored because of their extremely smaller thickness than the incident light wavelength [5, 37, 38]. Thus, in few-layered TMDC the NLO effect mainly depends on the crystal symmetry.

The generation mechanisms for NLO current are dominated by parity symmetry  $P$  [28]. Under  $P$ -conserved, NLO charge and spin current is absent. On the other hand, for  $P$ -broken, bulk photovoltaic effect is induced in the system. In general, bulk photovoltaic effect has two contributions: (i) shift current and (ii) injection current [4, 28, 31, 39–41]. (i) Shift current is the photoinduced spontaneous DC, which corresponds to the shift of electrons in real space during the optical excitation of electron. (ii) Injection current is net current for different

velocities between electron and hole owing to the population imbalance between them induced by photo-excitation. In the noncentrosymmetric system, the linearly polarized (LP) light irradiation solely induces the charge shift current, however the incident circularly polarized (CP) light solely induces the charge injection current [28].

In further, bi-circular light (BCL) is useful method to optically engineer the symmetry of electronic system [42–47]. BCL is the superposition of left-handed CP (LCP) light with the angular frequency  $n_1\omega$  and right-handed CP (RCP) light with  $n_2\omega$  ( $n_1 \neq n_2$ ), which forms the trajectory of rose curve. It is defined as

$$A_{BCL}(t) = A_L e^{in_1\omega t} + A_R e^{in_2\omega t - i\theta} + \text{c.c.}, \quad (1)$$

where  $A_{L(R)}$  is amplitude of LCP(RCP) light and  $\theta$  is a phase difference between LCP and RCP light. The application of BCL can artificially control the symmetry of electronic system and induce charge polarizations along the directions of leaves of BCL.

In this paper, we theoretically consider the NLO effects on metallic TMDCs. The metallic TMDCs such as NbSe<sub>2</sub>, NbS<sub>2</sub>, TaSe<sub>2</sub> and TaS<sub>2</sub> are metallic at room temperature, and successively show the charge density wave (CDW) phase [48, 49] and superconducting phase at low temperature [50–56]. In these materials, AB-stacking structure is most stable in nature and has different crystal symmetries for even and odd number of layers. Even-number-layered TMDCs have a space group  $D_{3d}$ , which respect to inversion and out-of-plane mirror symmetries. However odd-number-layered TMDCs have a space group  $D_{3h}$ , which break inversion symmetry. In further, owing to the broken inversion symmetry and a strong atomic spin-orbit coupling (SOC) field such as Nb and Ta atoms, its system possesses Ising-type SOC [52–54, 57–60], i.e., an effective Zeeman field that locks electron spins to out-of-plane directions by in-plane momentum.

In NbSe<sub>2</sub>, the SOC causes large spin splitting in the energy band structures of odd-number-layered systems (about

157 meV at K point), which leads to unconventional topological spin properties. In actual, we have shown that monolayer NbSe<sub>2</sub> can generate the spin Hall current under visible light irradiation owing to its finite topological spin Berry curvature [61]. Also, we have studied that the second-order NLO charge and spin Hall current of SHG process can be selectively generated in few-layered NbSe<sub>2</sub> according to the crystal symmetry and polarization of incident light [62].

Here, we extend our theoretical analysis to NLO charge and spin conductivities under BCL irradiation and DC photocurrent (shift and injection current) in few-layered NbSe<sub>2</sub>. We employ the effective tight-binding model (TBM) including the electron hopping among  $d_{z^2}$ ,  $d_{xy}$  and  $d_{x^2-y^2}$  orbitals of Nb atom and Ising-type SOC in order to describe the electronic structures of NbSe<sub>2</sub> around Fermi level. In general, the second-order NLO current is generated in odd-number-layered NbSe<sub>2</sub>, but absent in even-number-layered NbSe<sub>2</sub>. However, since BCL can manipulate the symmetry of electronic states, the NLO current can be generated even in even-number-layered NbSe<sub>2</sub>. In further, we find that the charge and spin shift current can be generated in odd-number-layered NbSe<sub>2</sub>, which is robust to the electronic scattering, i.e., topological current. In addition, the direction of generated shift current can be switched if LP light is altered to CP light. Our results will serve to design opt-spintronics devices on the basis of 2D materials to manipulate the charge and spin current and their directions by controlling the polarization of incident light which recasts the crystal symmetry.

This paper is organized as follows. In Sec. II we discuss the crystal symmetry, electronic structures of few-layered NbSe<sub>2</sub> based on the effective TBM. In Sec. III we briefly introduce the formula to calculate the second-order NLO conductivities and discuss their relation to the crystal symmetry. In Sec. IV we will show that incident BCL can control the symmetry of electronic system, which induces the NLO current along the directions of leaves of BCL. In Sec. V we show that the shift current has NLO selection rule depending on the crystal symmetry and polarization of incident light. It is also shown that charge and spin shift current can be switched if the polarization altered. Sec. VI provides the summary of our results. In Appendix, we give the symmetry analysis on NLO conductivity, NLO current induced by multi-leaf BCL and contour plots of integrand of NLO conductivities. In Supplementary Material, we show the imaginary parts of the NLO conductivities for BCL, rotational angle dependences of BCL on NLO conductivities, the derivation of shift- and injection-current conductivities, and the NLO conductivity for MoS<sub>2</sub> as a reference of a TMDC semiconductor [63].

## II. MODEL

We will show that the second-order NLO charge and spin conductivities strongly depend on the crystal symmetry and the polarization of light in metallic TMDC. In this paper, we employ NbSe<sub>2</sub> as an example of metallic TMDCs. Since NbSe<sub>2</sub> can be easily exfoliated because of van der Waals forces between layers, few-layered NbSe<sub>2</sub> such as monolayer,

AB-stacked bilayer and ABA-stacked trilayer is obtained. In particular we focus on two cases which are odd-number-layered (e.g. monolayer and ABA-stacked trilayer) and even-number-layered (e.g. AB-stacked bilayer) NbSe<sub>2</sub>. Figure 1 (a) shows the side view of few-layered NbSe<sub>2</sub>. The stacking structure is consisted by inserting B monolayer (180° rotation of A monolayer) between A monolayers, which is the most energetically stable stacking sequence in NbSe<sub>2</sub>. Each layer (monolayer) has the out-of-plane mirror symmetry  $M_z$  in perpendicular direction with respect to the plane of Nb atoms. Figures 1 (b) and (c) show the top views of monolayer and AB-stacked bilayer (ABA-stacked trilayer) NbSe<sub>2</sub>, respectively. Odd-number-layered NbSe<sub>2</sub> has a space group  $D_{3h}$ , which has mirror symmetry  $M_x M_z$  and no inversion symmetry. On the other hand, in even-number-layered NbSe<sub>2</sub>, the system has a space group  $D_{3d}$ , which respects to two mirror symmetries  $M_x M_z$  and  $M_y M_z$  and inversion symmetry  $P$ . Figure 1 (d) shows first Brillouin Zone (BZ) for few-layered NbSe<sub>2</sub>.

For NbSe<sub>2</sub>, we employ a multi-orbitals TBM which includes  $d_{z^2}$ ,  $d_{xy}$  and  $d_{x^2-y^2}$  orbitals of Nb atom, which can well describe the electronic states of NbSe<sub>2</sub> around Fermi energy ( $E_F = 0$  eV) [52, 61, 62, 64, 65]. The eigenvalue equation for the effective TBM is  $\hat{H}(\mathbf{k})|u_{n\mathbf{k}}\rangle = E_{n\mathbf{k}}|u_{n\mathbf{k}}\rangle$ , where  $n$  is the band index with spin states expressed as  $n = 1, 2, \dots, 6N$  ( $N$  is the number of layer),  $\mathbf{k} = (k_x, k_y)$  is the wave-number vector for 2D material and  $E_{n\mathbf{k}}$  is the eigenvalue for  $n$ -th band. The eigenvector for  $n$ -th band is defined as  $|u_{n\mathbf{k}}\rangle = (c_{n\mathbf{k},d_{z^2},\uparrow}, c_{n\mathbf{k},d_{xy},\uparrow}, c_{n\mathbf{k},d_{x^2-y^2},\uparrow}, c_{n\mathbf{k},d_{z^2},\downarrow}, c_{n\mathbf{k},d_{xy},\downarrow}, c_{n\mathbf{k},d_{x^2-y^2},\downarrow})^T$ , where  $(\dots)^T$  indicates the transpose of vector and  $c_{n\mathbf{k}\tau s}$  means the amplitude at atomic orbital  $\tau$  with spin  $s$  for the  $n$ -th energy band at  $\mathbf{k}$ . The Hamiltonian of monolayer NbSe<sub>2</sub> with Ising-type SOC is

$$\hat{H}_{\text{mono}}(\mathbf{k}) = \hat{\sigma}_0 \otimes \hat{H}_{\text{TNN}}(\mathbf{k}) + \hat{\sigma}_z \otimes \frac{1}{2} \lambda_{\text{SOC}} \hat{L}_z \quad (2)$$

with

$$\hat{H}_{\text{TNN}}(\mathbf{k}) = \begin{pmatrix} V_0 & V_1 & V_2 \\ V_1^* & V_{11} & V_{12} \\ V_2^* & V_{12}^* & V_{22} \end{pmatrix}, \quad \hat{L}_z = \begin{pmatrix} 0 & 0 & 0 \\ 0 & 0 & -2i \\ 0 & 2i & 0 \end{pmatrix}, \quad (3)$$

where  $\hat{\sigma}_0$  and  $\hat{\sigma}_z$  are Pauli matrices and  $\lambda_{\text{SOC}}$  is the Ising-type SOC parameter ( $\lambda_{\text{SOC}} = 0.0784$  eV for monolayer NbSe<sub>2</sub>).  $\hat{H}_{\text{TNN}}(\mathbf{k})$  includes the electron hoppings only among three  $d$ -orbitals of Nb atoms such as  $d_{z^2}$ ,  $d_{xy}$  and  $d_{x^2-y^2}$ , which are assumed up to third-nearest neighbor sites. Similarly, using the Hamiltonian of monolayer NbSe<sub>2</sub>  $\hat{H}_{\text{mono}}(\mathbf{k})$ , the Hamiltonians of bilayer and trilayer NbSe<sub>2</sub> can be written as

$$\hat{H}_{\text{bi}}(\mathbf{k}) = \begin{pmatrix} \hat{H}_{\text{mono}}(-\mathbf{k}) & \hat{H}_{\text{int}}(\mathbf{k}) \\ \hat{H}_{\text{int}}^\dagger(\mathbf{k}) & \hat{H}_{\text{mono}}(\mathbf{k}) \end{pmatrix} \quad (4)$$

and

$$\hat{H}_{\text{tri}}(\mathbf{k}) = \begin{pmatrix} \hat{H}_{\text{mono}}(\mathbf{k}) & \hat{H}_{\text{int}}(\mathbf{k}) & 0 \\ \hat{H}_{\text{int}}^\dagger(\mathbf{k}) & \hat{H}_{\text{mono}}(-\mathbf{k}) & \hat{H}_{\text{int}}(\mathbf{k}) \\ 0 & \hat{H}_{\text{int}}^\dagger(\mathbf{k}) & \hat{H}_{\text{mono}}(\mathbf{k}) \end{pmatrix}, \quad (5)$$

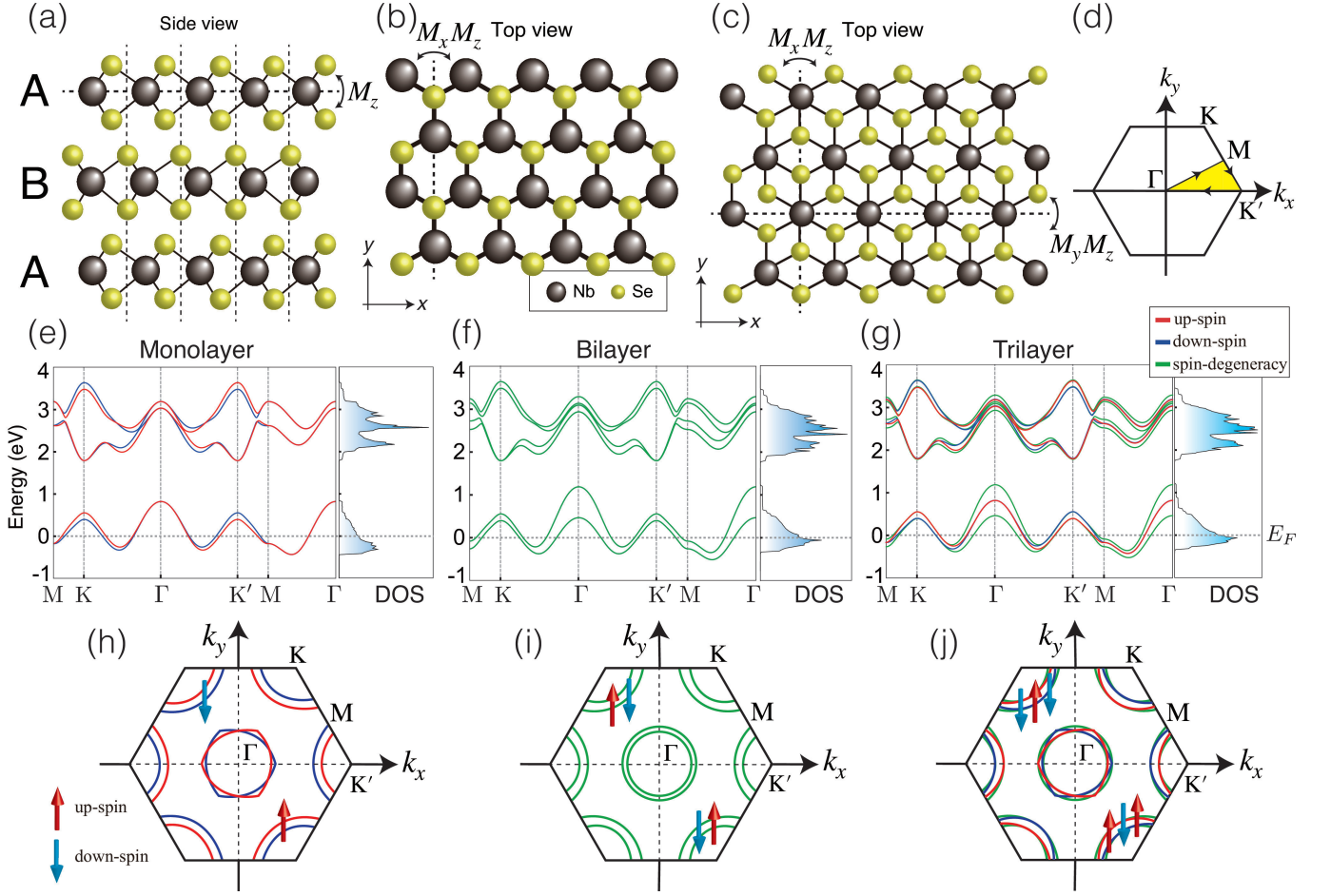

FIG. 1. Crystal structures of few-layered NbSe<sub>2</sub> with Nb (black) and Se (yellow) atoms. (a) Side view of crystal structure of monolayer (A), bilayer (AB) and trilayer (ABA) NbSe<sub>2</sub>. Monolayer NbSe<sub>2</sub> has mirror symmetry  $M_z$  in perpendicular direction with respect to the plane. Top views of crystal structures of (b) monolayer, (c) bilayer and trilayer NbSe<sub>2</sub>, respectively. Odd-number-layered NbSe<sub>2</sub> has mirror symmetry  $M_x M_z$  and no inversion symmetry, but even-number-layered NbSe<sub>2</sub> has inversion symmetry because of mirror symmetries  $M_x M_z$  and  $M_y M_z$ . (d) 1st BZ of NbSe<sub>2</sub>. Energy band structures and DOS of (e) monolayer, (f) bilayer and (g) trilayer NbSe<sub>2</sub> with SOC parameter  $\lambda_{\text{SOC}} = 0.0784$  eV, respectively. Fermi level is set to zero. Fermi surfaces of (h) monolayer, (i) bilayer and (j) trilayer NbSe<sub>2</sub>, respectively. Red, blue and green lines indicate up-spin, down-spin and spin-degeneracy states, respectively.

respectively [54]. Here, the interlayer coupling Hamiltonian  $\hat{H}_{\text{int}}(\mathbf{k})$  between monolayers is

$$\hat{H}_{\text{int}}(\mathbf{k}) = \begin{pmatrix} T_{01} & 0 & 0 \\ 0 & T_{02} & 0 \\ 0 & 0 & T_{02} \end{pmatrix}. \quad (6)$$

The details of matrix elements  $V_0$ ,  $V_1$ ,  $V_2$ ,  $V_{11}$ ,  $V_{12}$ ,  $V_{22}$ ,  $T_{01}$  and  $T_{02}$  can be found in Ref. [61, 62].

Figures 1 (e), (f) and (g) show the energy band structures and density of states (DOS) of monolayer, bilayer and trilayer NbSe<sub>2</sub>, respectively. Here, red, blue and green lines indicate up-spin, down-spin and spin-degeneracy states, respectively. Fermi energy  $E_F$  is set to 0 eV. Also, the system has a large energy band gap between the partially filled valence bands and empty conduction bands (about 1.5 eV). Because of the broken inversion symmetry in odd-number-layered NbSe<sub>2</sub>, the spin splitting bands can be seen, which show opposite spin

states at the valence band edges at K and K' points in the energy band structure, i.e., preservation of time-reversal symmetry. On the other hand, since even-number-layered NbSe<sub>2</sub> has crystal inversion symmetry, spin-degeneracy states appear in the energy band structure. In even-number-layered NbSe<sub>2</sub>, the interlayer interaction has larger effects on the valence band at  $\Gamma$  point than K and K' points, which leads to the large band splitting of valence band at  $\Gamma$  point. In trilayer NbSe<sub>2</sub>, the energy band consists of spin-splitting and spin-degeneracy states. It should be noted that the energy band structure of trilayer NbSe<sub>2</sub> can be understood by superposition of monolayer and bilayer NbSe<sub>2</sub>.

Figures 1 (h), (i) and (j) show the spin-dependent Fermi surfaces of monolayer, bilayer and trilayer NbSe<sub>2</sub>, respectively. In odd-number-layered NbSe<sub>2</sub>, the Fermi surface has up- and down-spin hole pockets centered at  $\Gamma$ , K and K' points. However, in even-number-layered NbSe<sub>2</sub>, no such spin splitting

occurs owing to the inversion symmetry. Thus, we show that the spin dependence of Fermi surfaces behaves differently for even- and odd-number-layered NbSe<sub>2</sub>.

### III. SECOND-ORDER NLO CHARGE AND SPIN CONDUCTIVITIES

Under irradiation of light with strong amplitude, the current density  $J_i$  can be expanded as follows, i.e.,  $J_i = J_i^{(1)} + J_i^{(2)} + J_i^{(3)} + \dots$ . Here,  $J_i^{(1)}$  is the linear optical current.  $J_i^{(2)}$  and  $J_i^{(3)}$  are second- and third-order NLO current. In second-order NLO effect, the generated current density  $J_i^{(2)}$  can be given as

$$J_i^{(2)} = \sum_{jk} \sum_{\omega_1 \omega_2} \sigma_{ijk}^{(2)}(\omega_1 + \omega_2; \omega_1, \omega_2) E_j(\omega_1) E_k(\omega_2), \quad (7)$$

where  $E_j(\omega_1)$  and  $E_k(\omega_2)$  are electric fields of incident light [3]. Note that  $(i, j, k)$  is  $x$ - or  $y$ -direction. In particular,  $i$  means the generation direction of NLO current.  $j$  and  $k$  are the polarization of  $E_j(\omega_1)$  and  $E_k(\omega_2)$ .  $\sigma_{ijk}^{(2)}(\omega_1 + \omega_2; \omega_1, \omega_2)$  is the second-order NLO conductivity. In general, the second-order NLO conductivity is given by (second-order) Kubo formula [4, 8, 9, 13, 15, 28, 62, 66–70]:

$$\begin{aligned} \sigma_{ijk}^{(2)}(\omega_1 + \omega_2; \omega_1, \omega_2) \\ \equiv -\frac{\hbar^2 e^2}{2S} \sum_{\mathbf{k}} (\Omega_{ijk}^{(2)}(\omega_1, \omega_2, \mathbf{k}) + \Omega_{ikj}^{(2)}(\omega_2, \omega_1, \mathbf{k})) \end{aligned} \quad (8)$$

with

$$\begin{aligned} \Omega_{ijk}^{(2)}(\omega_1, \omega_2, \mathbf{k}) &= \sum_{nml} \frac{j_{mn}^i}{E_{ml} E_{ln} (E_{mn} - \hbar(\omega_1 + \omega_2) - i\eta)} \\ &\times \left[ \frac{v_{nl}^j v_{lm}^k f_{ml}}{E_{ml} - \hbar\omega_2 - i\eta} - \frac{v_{nl}^k v_{lm}^j f_{ln}}{E_{ln} - \hbar\omega_2 - i\eta} \right] \\ &= \sum_{nml} \frac{f_{lm} v_{lm}^k}{E_{ml} (E_{ml} - \hbar\omega_2 - i\eta)} \\ &\times \left[ \frac{j_{mn}^i v_{nl}^j}{E_{nl} (E_{mn} - \hbar(\omega_1 + \omega_2) - i\eta)} \right. \\ &\left. - \frac{v_{mn}^j j_{nl}^i}{E_{mn} (E_{nl} - \hbar(\omega_1 + \omega_2) - i\eta)} \right], \end{aligned} \quad (9)$$

which describes the contribution of the interband optical transition [71].  $\Omega_{ijk}^{(2)}(\omega_1, \omega_2, \mathbf{k})$  is integrand of  $\sigma_{ijk}^{(2)}(\omega_1 + \omega_2; \omega_1, \omega_2)$  before considering intrinsic permutation symmetry, i.e.,  $\Omega_{ijk}^{(2)}(\omega_1, \omega_2, \mathbf{k}) = \Omega_{ikj}^{(2)}(\omega_2, \omega_1, \mathbf{k})$ . Note that  $(n, m, l)$  is the band indices including spin degree of freedom.  $v_{nl}^j = \langle u_{nk} | \mathbf{v} \cdot \mathbf{e}_j | u_{lk} \rangle$ , and  $\mathbf{v}$  is the group velocity operator, which written as  $\mathbf{v} = (\hat{v}_x, \hat{v}_y) = \frac{1}{\hbar} (\frac{\partial \hat{H}}{\partial k_x}, \frac{\partial \hat{H}}{\partial k_y})$  for 2D materials.  $\mathbf{e}_j(\mathbf{e}_k)$  is Jones vector. For example  $\mathbf{e}_x = (1, 0)^T$  for  $x$ -polarized light,  $\mathbf{e}_y = (0, 1)^T$  for  $y$ -polarized light,  $\mathbf{e}_L = \frac{1}{\sqrt{2}}(1, i)^T$  for

LCP light and  $\mathbf{e}_R = \frac{1}{\sqrt{2}}(1, -i)^T$  for RCP light.  $|u_{nk}\rangle$  is the eigenfunction with the eigenenergy  $E_{nk}$  and  $f(E_{nk})$  is Fermi-Dirac distribution function.  $E_{ml}$  is the difference between energy levels  $E_{mk}$  and  $E_{lk}$ , i.e.,  $E_{ml} \equiv E_{mk} - E_{lk}$ , and  $f_{ml}$  is also defined as  $f_{ml} \equiv f(E_{mk}) - f(E_{lk})$ .  $\omega_1$  and  $\omega_2$  are optical angular frequencies for the absorption process.  $\eta$  is infinitesimally small real number and  $S$  is the area of 2D system. Throughout this paper,  $\eta = 0.001$  eV is set for the calculation of conductivity.  $j_{mn}^i = \langle u_{mk} | \hat{J}_i^{(2)} | u_{nk} \rangle$ , where  $\hat{J}_i^{(2)}$  is current density operator, and represented as  $\hat{J}_i^{\text{charge}} = \frac{1}{2} \{-e \hat{\sigma}_0 \otimes \hat{I}_N, \hat{v}_i\}$  for charge current and  $\hat{J}_i^{\text{spin}} = \frac{1}{2} \{ \frac{\hbar}{2} \hat{\sigma}_z \otimes \hat{I}_N, \hat{v}_i \}$  for spin current. Here,  $\hat{I}_N$  is the  $N \times N$  identity matrix and in particular  $N = 3, 6, 9$  is used for monolayer, bilayer and trilayer NbSe<sub>2</sub>, respectively.

In Eqs. (8) and (9), when  $\omega_1 + \omega_2 = \omega_3$  and  $\omega_1 \neq \omega_2 \neq \omega_3 \neq 0$ , the process is called as sum frequency generation (SFG) [16–18]. In particular, if  $\omega_1 = \omega_2 \equiv \omega \neq 0$  and  $\omega_3 = 2\omega$ , the process becomes SHG. In addition, when  $\omega_1 - \omega_2 = \omega_3$  and  $\omega_1 \neq \omega_2 \neq \omega_3 \neq 0$ , the process is called as difference frequency generation (DFG) [72, 73], which can express the bulk photovoltaic effect if  $\omega_1 = -\omega_2 \equiv \omega \neq 0$ .

The NLO conductivities are strongly influenced by the crystal symmetries [3]. For the SHG process in the odd-number-layered NbSe<sub>2</sub> where the inversion symmetry is broken, the NLO charge and spin conductivities of SHG process  $\sigma_{ijk}^{\text{charge}}(2\omega; \omega, \omega)$  and  $\sigma_{ijk}^{\text{spin}}(2\omega; \omega, \omega)$  have following relations:

$$\begin{aligned} \sigma_{yyy}^{\text{charge}}(2\omega; \omega, \omega) &= -\sigma_{yxx}^{\text{charge}}(2\omega; \omega, \omega) \\ &= -\sigma_{xyx}^{\text{charge}}(2\omega; \omega, \omega) = -\sigma_{xxy}^{\text{charge}}(2\omega; \omega, \omega) \end{aligned} \quad (10)$$

and

$$\begin{aligned} \sigma_{xxx}^{\text{spin}}(2\omega; \omega, \omega) &= -\sigma_{yyy}^{\text{spin}}(2\omega; \omega, \omega) \\ &= -\sigma_{yxy}^{\text{spin}}(2\omega; \omega, \omega) = -\sigma_{yyx}^{\text{spin}}(2\omega; \omega, \omega). \end{aligned} \quad (11)$$

The other elements are absent. On the other hand, in even-number-layered NbSe<sub>2</sub>, the NLO current is always absent owing to the inversion symmetry. These results are summarized in Table I. In addition, the another derivation of these relations using crystal symmetry operation is presented in Appendix A.

### IV. NLO CONDUCTIVITY UNDER IRRADIATION OF BCL

BCL can artificially control the symmetry of electronic system [42–47, 74–76]. BCL is the superposition of LCP and RCP light with different angular frequencies  $n_1\omega$  and  $n_2\omega$ , where  $n_1$  and  $n_2$  are different integers. The vector potential for BCL can be formulated as

$$\begin{aligned} A(t) &= A_L e^{in_1\omega t} + A_R e^{in_2\omega t - i\theta} + \text{c.c.} \\ &= \frac{1}{\sqrt{2}} (A_x + iA_y) e^{in_1\omega t} + \frac{1}{\sqrt{2}} (A_x - iA_y) e^{in_2\omega t - i\theta} + \text{c.c.}, \end{aligned} \quad (12)$$

TABLE I. Second-order NLO charge and spin conductivities of SHG process  $\sigma_{ijk}^{\text{charge}}(2\omega; \omega, \omega)$  and  $\sigma_{ijk}^{\text{spin}}(2\omega; \omega, \omega)$  for odd- and even-number-layered NbSe<sub>2</sub> [62]

	second-order NLO charge conductivity	second-order NLO spin conductivity
odd-number-layer (D <sub>3h</sub> )	$\sigma_{yyy}^{\text{charge}} = -\sigma_{yxx}^{\text{charge}} = -\sigma_{xyx}^{\text{charge}} = -\sigma_{xxy}^{\text{charge}}$	$\sigma_{xxx}^{\text{spin}} = -\sigma_{xyy}^{\text{spin}} = -\sigma_{yxy}^{\text{spin}} = -\sigma_{yyx}^{\text{spin}}$
even-number-layer (D <sub>3d</sub> )	zero	zero

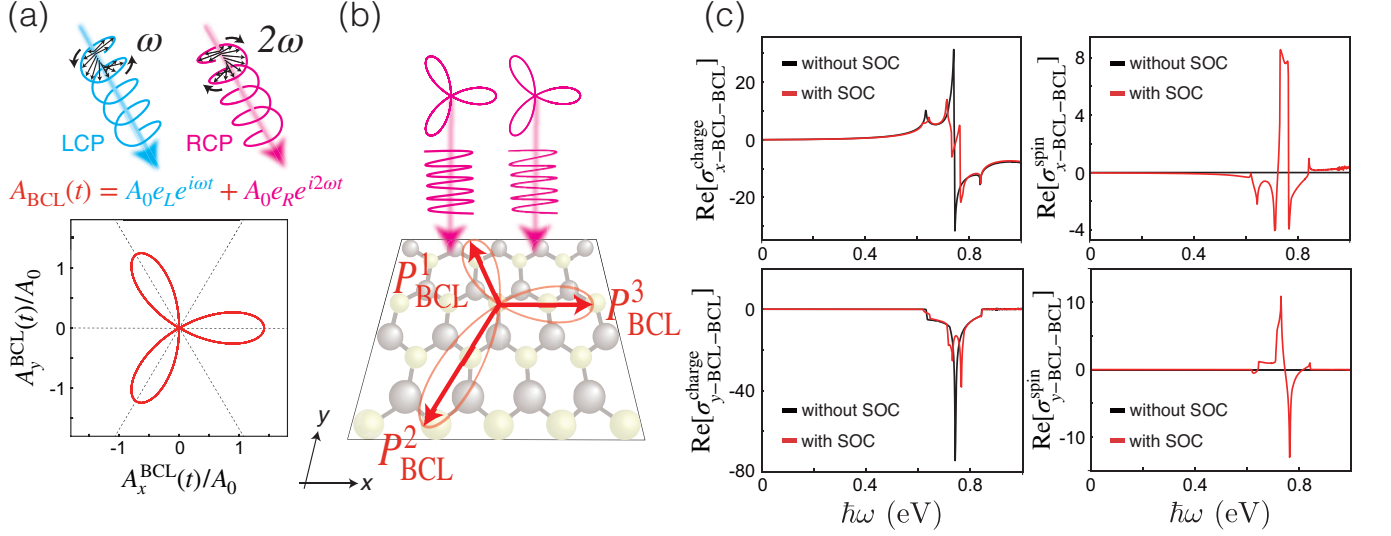

FIG. 2. (a) Trajectory of 3-leaf BCL ( $n_1 : n_2 = 1 : 2$ ,  $\theta = 0$ ). (b) Schematic of three induced polarizations  $P_{\text{BCL}}^1$ ,  $P_{\text{BCL}}^2$  and  $P_{\text{BCL}}^3$  by irradiating 3-leaf BCL. (c) Real parts of second-order NLO conductivities  $\sigma_{x\text{-BCL-BCL}}^{\text{charge}}(n_1\omega, n_2\omega)$ ,  $\sigma_{y\text{-BCL-BCL}}^{\text{charge}}(n_1\omega, n_2\omega)$ ,  $\sigma_{x\text{-BCL-BCL}}^{\text{spin}}(n_1\omega, n_2\omega)$  and  $\sigma_{y\text{-BCL-BCL}}^{\text{spin}}(n_1\omega, n_2\omega)$  for monolayer NbSe<sub>2</sub> under irradiation of BCL with 3-leaf. Black and red lines indicate the NLO conductivities without and with SOC. The units of  $\sigma_{i\text{-BCL-BCL}}^{\text{charge}}(n_1\omega, n_2\omega)$  and  $\sigma_{i\text{-BCL-BCL}}^{\text{spin}}(n_1\omega, n_2\omega)$  are  $e^3/\hbar$  and  $e^2$ , respectively.

where  $A_{L(R)}$  is the amplitude of the LCP(RCP) light.  $\theta$  is the phase difference between LCP and RCP light. In general, the trajectory of BCL is a rose curve with  $(n_1 + n_2)/\text{gcd}(n_1, n_2)$ -fold rotation symmetry. Here,  $\text{gcd}(n_1, n_2)$  means the great common divisor of two integers  $n_1, n_2$ . For example, there are 3-leaf BCL with 3-fold rotation symmetry  $C_3$ , 4-leaf BCL with 4-fold rotation symmetry  $C_4$  and 5-leaf BCL with 5-fold rotation symmetry  $C_5$ .

The induced current density  $J_i^{\text{BCL}}$  under the irradiation of BCL, i.e.,  $E_{\text{BCL}}(t) = E_L e^{in_1\omega t} + E_R e^{in_2\omega t} + \text{c.c.} = \sum_{a=L,R} \sum_{n_a} E_a e^{in_a\omega t}$  with  $(n_L, n_R) \equiv (n_1, n_2)$ , can be written as

$$J_i^{\text{BCL}} = \sum_{ab} \sum_{n_a n_b} \sigma_{iab}^{(2)}((n_a + n_b)\omega; n_a\omega, n_b\omega) E_a E_b.$$

Furthermore, the NLO conductivity for BCL irradiation be-

comes

$$\begin{aligned} & \sigma_{i\text{-BCL-BCL}}^{(2)}(n_1\omega, n_2\omega) \\ &= \sum_{ab} \sigma_{iab}^{(2)}((n_a + n_b)\omega; n_a\omega, n_b\omega) \\ &= \sigma_{iLL}^{(2)}(2n_1\omega; n_1\omega, n_1\omega) + \sigma_{iLR}^{(2)}((n_1 + n_2)\omega; n_1\omega, n_2\omega) \\ & \quad + \sigma_{iRL}^{(2)}((n_2 + n_1)\omega; n_2\omega, n_1\omega) + \sigma_{iRR}^{(2)}(2n_2\omega; n_2\omega, n_2\omega), \end{aligned} \quad (13)$$

where the subscript BCL and L (R) mean the injection of BCL and LCP (RCP), respectively. The NLO conductivities are numerically calculated by using Eqs. (8) and (9).

Figure 2 (a) shows the trajectory of incident BCL with 3-leaf ( $n_1 : n_2 = 1 : 2$ ,  $\theta = 0$ ). The 3-leaf BCL can break the mirror symmetry  $M_x$  and then induce three polarizations  $P_{\text{BCL}}^1$ ,  $P_{\text{BCL}}^2$  and  $P_{\text{BCL}}^3$  along the directions of three leaves of 3-leaf BCL (see Fig. 2 (b)). Figure 2 (c) shows the  $\omega$  dependence of the real parts of second-order NLO conductivities  $\sigma_{i\text{-BCL-BCL}}^{(2)}(n_1\omega, n_2\omega)$  for monolayer NbSe<sub>2</sub> under irradiation of 3-leaf BCL. In previous work, we have shown that under LP light irradiation, the charge and spin Hall current can

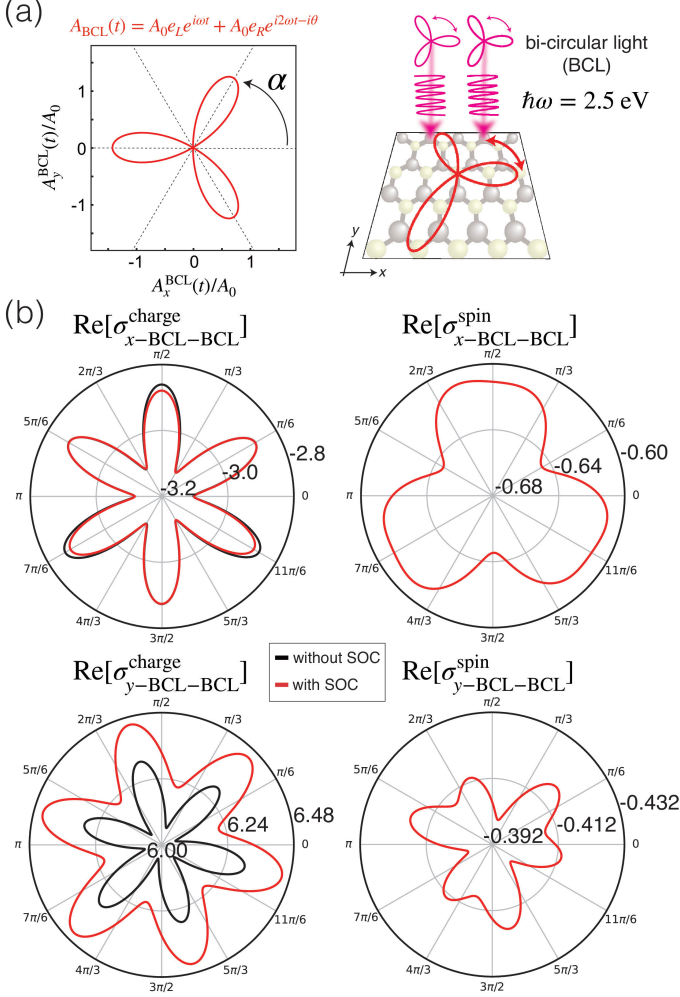

FIG. 3. (a) Trajectory of 3-leaf BCL with rotational angle  $\alpha$  ( $n_1 : n_2 = 1 : 2$ ,  $\alpha \neq 0$ ). (b)  $\alpha$ -dependence on real parts of second-order NLO charge and spin conductivities for monolayer NbSe<sub>2</sub> under irradiation of 3-leaf BCL of  $\hbar\omega = 2.5$  eV. Black and red lines indicate  $\sigma_{i-\text{BCL-BCL}}^{(2)}$  without and with SOC. The units of  $\sigma_{i-\text{BCL-BCL}}^{\text{charge}}$  and  $\sigma_{i-\text{BCL-BCL}}^{\text{spin}}$  are  $e^3/\hbar$  and  $e^2$ , respectively.

be generated only either in  $y$ - or  $x$ -direction for monolayer NbSe<sub>2</sub> [62]. However, since the 3-leaf BCL breaks  $M_x$  symmetry, the current can be generated in both  $x$ - and  $y$ -directions.

Figure 3 (a) shows the trajectory of 3-leaf BCL with rotational angle  $\alpha$  ( $n_1 : n_2 = 1 : 2$ ,  $\alpha \neq 0$ ). Here,  $\alpha$  has a following relation with  $\theta$ :

$$\alpha = -\frac{n_1}{n_1 + n_2}\theta, \quad (14)$$

which is defined as rotational angle from  $x$ -axis. Figure 3 (b) shows  $\alpha$ -dependence on real parts of second-order NLO conductivities  $\sigma_{i-\text{BCL-BCL}}^{(2)}$  for monolayer NbSe<sub>2</sub> under irradiation of 3-leaf BCL of  $\hbar\omega = 2.5$  eV. The charge current is generated along the three different axes of the induced

polarizations by incident BCL of 3-leaf, resulting in the appearance of six equivalent peaks for  $\alpha$  ( $0 \leq \alpha < 2\pi$ ). On the other hand, the magnitude of spin current has only three equivalent peaks. As shown in Supplementary material, the NLO conductivities for up- and down-spin states have three equivalent peaks, but point in opposite directions to each other. In general, the number of generated directions of charge and spin current are twice as different.

In Appendix A, we derive the selection rules of second-order NLO conductivities of NbSe<sub>2</sub> under irradiation of generic BCL. In Appendix B, we provide the second-order NLO conductivities of monolayer NbSe<sub>2</sub> for the irradiation of BCL with 4-, 5-, 6- and 7-leaf. As shown in Fig. 8 of Appendix B, it is found that the peaks of NLO conductivities in the range of  $0 < \hbar\omega < 1$  shift lower with increase of leaves of BCL. These shifts are originated from the factor of  $(n_1 + n_2)$  in the denominator of Eq. (9).

If  $n_1 : n_2 = 1 : 1$  with  $\theta = 0$ , the trajectory of incident light is identical to  $x$ -polarized light, i.e.,

$$A_{\text{BCL}}(t) = A_L e^{i\omega t} + A_R e^{i\omega t} + \text{c.c.} = \sqrt{2} A_x e^{i\omega t} + \text{c.c.} \quad (15)$$

Therefore, this case reproduces the results of SHG process [62]. The details are shown in Supplementary material [63].

In even-number-layered NbSe<sub>2</sub>, the second-order NLO current is always absent because of the inversion symmetry [62]. However, the irradiation of BCL with odd-number of leaf or even-number of leaf with  $\alpha \neq 0$  can break the inversion symmetry, resulting in the generation of charge and spin current. As shown in Appendix C, for irradiation of RCP and LCP light with different optical angular frequencies, the NLO current is generated, i.e., no cancellation of current even in the presence of spatial inversion symmetry. Figure 4 (a) shows the real parts of  $\sigma_{i-\text{BCL-BCL}}^{(2)}(n_1\omega, n_2\omega)$  for bilayer NbSe<sub>2</sub> under irradiation of 3-leaf BCL. Owing to the broken mirror symmetry  $M_x$ , the NLO charge and spin current can be generated only either in  $x$ - or  $y$ -direction for bilayer NbSe<sub>2</sub>. Thus, the irradiation of BCL can generate the current even in even-number-layered NbSe<sub>2</sub>.

In further, we should notice that in an energy range of  $0 < \hbar\omega < 0.1$ ,  $\text{Re}[\sigma_{x-\text{BCL-BCL}}^{\text{charge}}]$  and  $\text{Re}[\sigma_{y-\text{BCL-BCL}}^{\text{spin}}]$  have the peaks for bilayer NbSe<sub>2</sub>. These peaks are attributed to interband optical transition between highest valence and lowest conduction bands of energy bands shown in Fig. 4 (b), which cause infrared light absorption. On the other hand, the infrared light absorption is absent in semiconductor TMDC such as MoS<sub>2</sub> because of the large band gap between valence and conduction bands ( $\Delta E \approx 2.0$  eV).

Figure 4 (c) schematically summarizes the induced charge and spin current directions in bilayer NbSe<sub>2</sub> under irradiation of 3-leaf BCL. Since BCL breaks the inversion symmetry of electronic system, the NLO current is generated even in bilayer NbSe<sub>2</sub>. Note that the charge current is induced along  $P_{\text{BCL}}^3$  in Fig. 2 (b), but the spin current is induced in perpendicular to the charge current.

In Appendix D, we provide the second-order NLO conductivities for trilayer NbSe<sub>2</sub> under BCL irradiation. The second-order NLO conductivities of trilayer NbSe<sub>2</sub> consist of three

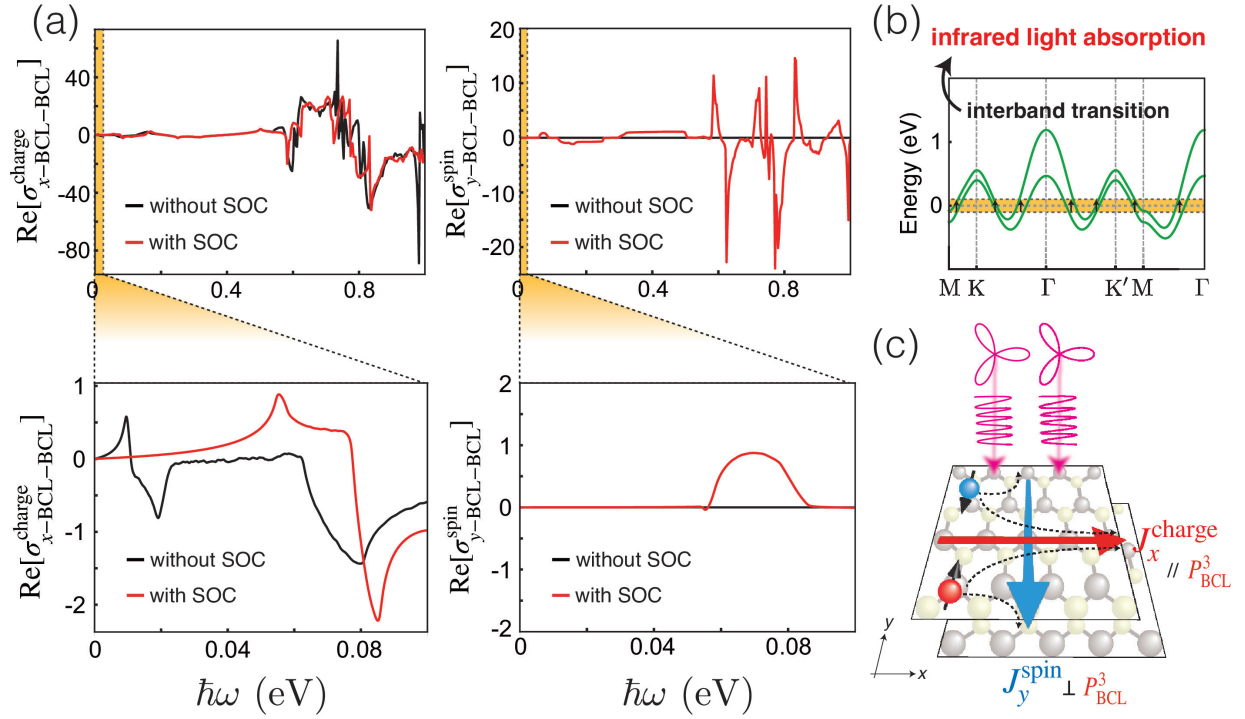

FIG. 4. (a) Real parts of second-order NLO conductivities  $\sigma_{x\text{-BCL-BCL}}^{\text{charge}}(n_1\omega, n_2\omega)$  and  $\sigma_{y\text{-BCL-BCL}}^{\text{spin}}(n_1\omega, n_2\omega)$  for bilayer NbSe<sub>2</sub> under irradiation of BCL with 3-leaf. In an energy range of  $0 < \hbar\omega < 0.1$ , the charge and spin conductivities have peaks. (b) Its peaks correspond to infrared light absorption for optical interband transition in energy band of bilayer NbSe<sub>2</sub>. (c) Schematics of generated charge and spin current by irradiating BCL with 3-leaf. Black and red lines indicate  $\sigma_{i\text{-BCL-BCL}}^{(2)}(n_1\omega, n_2\omega)$  without and with SOC. The units of  $\sigma_{i\text{-BCL-BCL}}^{\text{charge}}(n_1\omega, n_2\omega)$  and  $\sigma_{i\text{-BCL-BCL}}^{\text{spin}}(n_1\omega, n_2\omega)$  are  $e^3/\hbar$  and  $e^2$ , respectively.

optical transition processes: (i) intralayer optical transition of monolayer NbSe<sub>2</sub>, (ii) intra- and interlayer optical transition of bilayer NbSe<sub>2</sub> and (iii) interlayer optical transitions between monolayer and bilayer NbSe<sub>2</sub>. Under irradiation of LP light, the process (ii) is absent. However, BCL of 3-leaf makes all three processes finite.

## V. SHIFT- AND INJECTION-CURRENT CONDUCTIVITIES

DFG with  $\omega_1 = -\omega_2 \equiv \omega \neq 0$  induces the DC photocurrent, i.e., bulk photovoltaic effect. In Eq. (7), the DC photocurrent  $J_i^{(2)}$  can be obtained as

$$\begin{aligned}
 J_i^{(2)} &= \sum_{jk} \{ \sigma_{ijk}^{(2)}(0; \omega, -\omega) E_j(\omega) E_k(-\omega) \\
 &\quad + \sigma_{ijk}^{(2)}(0; -\omega, \omega) E_j(-\omega) E_k(\omega) \} \\
 &= \sum_{jk} \{ \sigma_{ijk}^{(2)}(0; \omega, -\omega) E_j(\omega) E_k(-\omega) + \text{c.c.} \} \\
 &= \sum_{jk} 2\sigma_{ijk}^{(2)}(0; \omega, -\omega) E_j(\omega) E_k(-\omega),
 \end{aligned} \tag{16}$$

where the DC photoconductivity based on Eqs. (8) and (9) follows the identities  $\sigma_{ijk}^{(2)}(0; -\omega, \omega) = -\sigma_{ijk}^{(2)}(0; \omega, -\omega) =$

$[\sigma_{ijk}^{(2)}(0; \omega, -\omega)]^*$ . The numerical results are shown in Supplementary material [63], which strongly depends on the crystal symmetry, i.e., generation of current for odd-number-layered NbSe<sub>2</sub>, but absence for even-number-layered NbSe<sub>2</sub>. The bulk photovoltaic effect includes the generation of shift and injection current. In this section, we derive the shift/injection-current conductivities, and find that these conductivities depend on the crystal symmetry and polarization of incident light for monolayer NbSe<sub>2</sub>.

### A. Shift and injection current under LP light irradiation

The DC photocurrent can be separated into two different optically induced DC current, i.e., (i) shift current and (ii) injection current. (i) Shift current is induced polarization current owing to the shift of electron position by irradiating light [28]. The induced polarization of electrons  $P_i$  is written as

$$P_i = e \int_{\text{BZ}} \frac{d\mathbf{k}}{(2\pi)^3} \sum_m f_m \xi_{mm}^i, \tag{17}$$

where  $\xi_{mm}^i$  is the Berry connection of  $m$ -th band and  $\xi_{mm}^i = i \langle u_{mk} | \frac{\partial}{\partial k_i} | u_{mk} \rangle$  [4]. Berry connection is also interpreted as the Wannier center of wave function [77–79]. Thus, the origin of



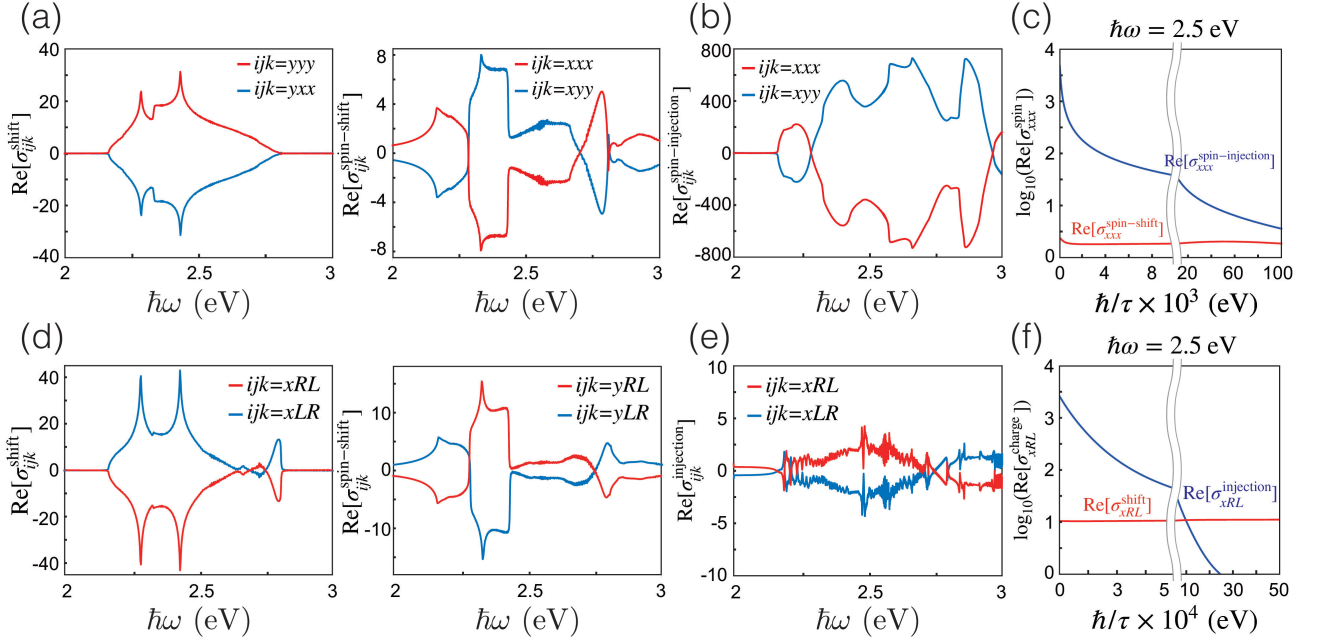

FIG. 5. Real parts of charge and spin (a, d) shift- and (b, e) injection-current conductivities for monolayer NbSe<sub>2</sub> under LP and CP light irradiation, respectively. (c, f)  $\tau$ -dependences of shift (red) and injection (blue) current conductivities for linearly  $x$ -polarized and RCP light of  $\hbar\omega = 2.5$  eV. Here, plots of the NLO conductivities are shown in logarithmic scale. The units of NLO charge and spin conductivities are  $e^3/\hbar$  and  $e^2$ , respectively.

the shift current is the change of the polarization  $P_i$ , i.e., the Berry connection difference between valence and conduction bands  $\xi_{mm}^i - \xi_{ll}^i$  by photo-excitation. Note that  $l(m)$  is the unoccupied (occupied) band index. (ii) Injection current is induced net current for the distribution of asymmetric electron and hole velocities  $\Delta_{lm}^i = v_{ll}^i - v_{mm}^i$  owing to the population imbalance by photo-excitation in the momentum space [28].

Using a sum rule for the generalized derivative  $r_{ml;i}^j$  of position  $r_{ml}^j = \langle u_{mk} | \mathbf{r} \cdot \mathbf{e}_j | u_{lk} \rangle$  in the DC photoconductivity  $\sigma_{ijk}^{(2)}(0; \omega, -\omega)$  [4, 28, 39–41], the DC photoconductivity can be separated into shift/injection-current conductivities. Here,  $r_{ml;i}^j$  is given as

$$\begin{aligned} r_{ml;i}^j &= \frac{\partial r_{ml}^j}{\partial k_i} - i[\xi_{mm}^i - \xi_{ll}^i]r_{ml}^j \\ &= -iR_{ml}^i(\mathbf{k})r_{ml}^j, \end{aligned} \quad (18)$$

which depends on the difference of Berry connections, i.e., contribution for shift current. Note that  $R_{ml}^i(\mathbf{k})$  is shift vector and given as

$$R_{ml}^i(\mathbf{k}) = \frac{\partial \phi_{ml}^j}{\partial k_i} + (\xi_{mm}^i - \xi_{ll}^i), \quad (19)$$

where  $\phi_{ml}^j$  is phase of group velocity  $v_{ml}^j = \langle u_{mk} | \mathbf{v} \cdot \mathbf{e}_j | u_{lk} \rangle = |v_{ml}^j|e^{-i\phi_{ml}^j}$ . For the numerical calculation, it is better to rewrite

the generalized derivative  $r_{ml;i}^j$  as follow,

$$r_{ml;i}^j = \frac{r_{ml}^j \Delta_{lm}^i + r_{ml}^i \Delta_{lm}^j}{\omega_{ml}} - i\hbar^2 \sum_{n \neq m, l} \left( \frac{v_{mn}^i v_{nl}^j}{E_{ml} E_{mn}} - \frac{v_{mn}^j v_{nl}^i}{E_{ml} E_{nl}} \right). \quad (20)$$

Using the relation of  $r_{ml}^i$  and  $v_{ml}^i$  for interband optical transition, i.e.,

$$r_{ml}^i = \begin{cases} \frac{v_{ml}^i}{i\omega_{ml}} & (m \neq l) \\ 0 & (m = l) \end{cases}, \quad (21)$$

Eq. (20) is rewritten as the expression with velocity. Thus,  $r_{ml;i}^j$  becomes

$$\begin{aligned} r_{ml;i}^j &= -\hbar R_{ml}^i(\mathbf{k}) \frac{v_{ml}^j}{E_{ml}} \\ &= -\frac{2i\hbar^2}{E_{ml}} \left[ \frac{v_{ml}^i (v_{ll}^j - v_{mm}^j)}{E_{ml}} + \frac{v_{ml}^j (v_{ll}^i - v_{mm}^i)}{E_{ml}} \right. \\ &\quad \left. + \sum_n \left( \frac{v_{mn}^i v_{nl}^j}{E_{mn}} - \frac{v_{mn}^j v_{nl}^i}{E_{nl}} \right) \right], \end{aligned} \quad (22)$$

where  $v_{ml}^i$  is  $\langle u_{mk} | J_i^{\text{charge}} | u_{lk} \rangle = \frac{1}{2} \langle u_{mk} | \{-e\hat{\sigma}_0 \otimes \hat{I}_N, \hat{v}_i\} | u_{lk} \rangle$  for charge current and  $\langle u_{mk} | J_i^{\text{spin}} | u_{lk} \rangle = \frac{1}{2} \langle u_{mk} | \{\frac{\hbar}{2}\hat{\sigma}_z \otimes \hat{I}_N, \hat{v}_i\} | u_{lk} \rangle$  for spin current. Thus, by substituting the second-term of Eq. (22) in the summation part of Eq. (9) with  $\omega_1 = -\omega_2 \equiv \omega \neq 0$ ,

the DC photoconductivity becomes  $\sigma_{ijk}^{(2)}(0; \omega, -\omega) = \sigma_{ijk}^{\text{shift}}(0; \omega, -\omega) + \sigma_{ijk}^{\text{injection}}(0; \omega, -\omega)$ . Here,  $\sigma_{ijk}^{\text{shift}}(0; \omega, -\omega)$  is shift-current and  $\sigma_{ijk}^{\text{injection}}(0; \omega, -\omega)$  is injection-current conductivities.

For LP light irradiation,  $\sigma_{ijk}^{\text{shift}}(0; \omega, -\omega)$  and  $\sigma_{ijk}^{\text{injection}}(0; \omega, -\omega)$  are derived as [39]

$$\sigma_{ijk}^{\text{shift}}(0; \omega, -\omega) = -\frac{i\hbar e^3}{S} \sum_{\mathbf{k}} \sum_{mn} f_{nm} \frac{\alpha_{mn}^{jk}(\mathbf{k}) R_{nm}^i(\mathbf{k})}{E_{mn}^2 (E_{mn} - \hbar\omega - i\eta)} \quad (23)$$

with transition intensity

$$\alpha_{mn}^{jk}(\mathbf{k}) = \frac{1}{2} (v_{mn}^j(\mathbf{k}) v_{nm}^k(\mathbf{k}) + v_{mn}^k(\mathbf{k}) v_{nm}^j(\mathbf{k})), \quad (24)$$

and

$$\sigma_{ijk}^{\text{injection}}(0; \omega, -\omega) = \tau \frac{i\hbar e^3}{S} \sum_{\mathbf{k}} \sum_{mn} f_{nm} \frac{\alpha_{mn}^{jk}(\mathbf{k}) \Delta_{mn}^i(\mathbf{k})}{E_{mn}^2 (E_{mn} - \hbar\omega - i\eta)}, \quad (25)$$

where the dummy variables ( $m \rightarrow n, l \rightarrow m$ ) are interchanged and  $\tau = \hbar/\eta$ . For spin current, the superscripts of these conductivities are rewritten as ‘‘spin – shift’’ and ‘‘spin – injection’’. It should be noted that the spin-dependent position and velocity difference for the direction of generated current are  $r_{ml;i(\text{spin})}^j$  and  $\Delta_{lm}^{i-\text{spin}}$ . According to Ref. [28], since these approaches of length [4] and velocity gauges [39] should be equivalent, we use the expression of velocity gauge for our calculation.

Since the shift current strongly depends on the crystal symmetry, the charge and spin shift current can be generated in odd-number-layered NbSe<sub>2</sub>, but absent in even-number-layered NbSe<sub>2</sub>. The finite charge and spin shift-current conductivities can be obtained as

$$\begin{aligned} \sigma_{yyy}^{\text{shift}}(0; \omega, -\omega) &= -\sigma_{yxx}^{\text{shift}}(0; \omega, -\omega) \\ &= -\sigma_{xyx}^{\text{shift}}(0; \omega, -\omega) = -\sigma_{xxy}^{\text{shift}}(0; \omega, -\omega) \end{aligned} \quad (26)$$

and

$$\begin{aligned} \sigma_{xxx}^{\text{spin-shift}}(0; \omega, -\omega) &= -\sigma_{xyy}^{\text{spin-shift}}(0; \omega, -\omega) \\ &= -\sigma_{yxy}^{\text{spin-shift}}(0; \omega, -\omega) = -\sigma_{yyx}^{\text{spin-shift}}(0; \omega, -\omega), \end{aligned} \quad (27)$$

respectively. The other elements are absent for monolayer NbSe<sub>2</sub>. These relations are equivalent to the results of SHG process [62].

Figure 5 (a) shows the charge and spin shift-current conductivities for monolayer NbSe<sub>2</sub> under irradiation of LP light. Because of the broken inversion symmetry, the charge and spin shift current can be generated in  $y$ - and  $x$ -directions for linearly  $x$ -polarized light, respectively. On the other hand, for linearly  $y$ -polarized light, the charge and spin shift current can be generated in  $y$ - and  $x$ -directions, respectively. We should note that the generated spin shift current is perpendicular to the charge current.

The appearance of charge (spin) shift current along  $y$  ( $x$ )-direction can also be understood by inspecting  $\alpha_{mn}^{jk}(\mathbf{k})$  with  $jk = xx, yy$  and  $R_{nm}^i(\mathbf{k})$ , which are contained in the intergrand of Eq. (23). When the product  $\alpha_{mn}^{jk}(\mathbf{k}) R_{nm}^i(\mathbf{k})$  with  $jk = xx, yy$  is even with respect to  $\pi$ -rotation, we obtain the finite charge (spin) shift current along  $y$  ( $x$ )-direction. The contour plots of  $\alpha_{mn}^{jk}(\mathbf{k})$  and  $R_{nm}^i(\mathbf{k})$  can be found in Fig. 11 in Appendix E. Since  $\alpha_{mn}^{jk}(\mathbf{k})$  with  $jk = xx, yy$  is even for  $\pi$ -rotation, the shift current is absent for  $R_{nm}^i(\mathbf{k})$  with odd parity.

On the other hand, the finite elements of injection-current conductivities have a following relation:

$$\begin{aligned} \sigma_{xxx}^{\text{spin-injection}}(0; \omega, -\omega) &= -\sigma_{xyy}^{\text{spin-injection}}(0; \omega, -\omega) \\ &= -\sigma_{yxy}^{\text{spin-injection}}(0; \omega, -\omega) = -\sigma_{yyx}^{\text{spin-injection}}(0; \omega, -\omega), \end{aligned} \quad (28)$$

however, the other elements are absent for monolayer NbSe<sub>2</sub>.

Figure 5 (b) shows the spin injection-current conductivities for monolayer NbSe<sub>2</sub> under LP light irradiation. Owing to the broken inversion symmetry, the spin injection current can be generated in  $x$ -direction for  $x$ - and  $y$ -polarized light. As shown in Fig. 5 (c), the magnitude of the generated spin injection current is larger than that of spin shift current owing to  $\tau$ -dependence of injection current. Here, the plots of conductivities are shown in logarithmic scale. Thus, if  $\tau$  increases, the magnitude of injection current becomes larger, but that of shift current is robust, i.e., topologically protected.

We also find that the parity of  $\alpha_{mn}^{jk}(\mathbf{k}) \Delta_{mn}^i(\mathbf{k})$  in the intergrand of Eq. (25) is involved in the generation of injection current. As shown in Fig. 11 in Appendix E,  $\alpha_{mn}^{jk}(\mathbf{k})$  with  $jk = xx, yy$  and  $\Delta_{mn}^{x-\text{spin}}(\mathbf{k})$  are even for  $\pi$ -rotation. Thus, the spin injection current is generated in  $x$ -direction, because  $\alpha_{mn}^{jk}(\mathbf{k}) \Delta_{mn}^i(\mathbf{k})$  with  $jk = xx, yy$  is even with respect to  $\pi$ -rotation.

## B. Shift and injection current under CP light irradiation

Similarly, for irradiation of CP light, the shift/injection-current conductivities are given as

$$\sigma_{iRL}^{\text{shift}}(0; \omega, -\omega) = \frac{e^3}{\hbar S} \sum_{\mathbf{k}} \sum_{mn} f_{nm} \frac{\Omega_{mn}^{xy}(\mathbf{k}) - \Omega_{mn}^{yx}(\mathbf{k})}{E_{mn} - \hbar\omega - i\eta} R_{nm}^i(\mathbf{k}) \quad (29)$$

and

$$\sigma_{iRL}^{\text{injection}}(0; \omega, -\omega) = \frac{\tau e^3}{\hbar S} \sum_{\mathbf{k}} \sum_{mn} f_{nm} \frac{\Omega_{mn}^{xy}(\mathbf{k}) - \Omega_{mn}^{yx}(\mathbf{k})}{E_{mn} - \hbar\omega - i\eta} \Delta_{mn}^i(\mathbf{k}) \quad (30)$$

with Berry curvature

$$\Omega_{mn}^{xy}(\mathbf{k}) = -\Omega_{mn}^{yx}(\mathbf{k}) = -\hbar^2 \frac{\text{Im}(v_{nm}^x(\mathbf{k}) v_{nm}^y(\mathbf{k}))}{E_{mn}^2}. \quad (31)$$

Note that the subscript  $RL$  means irradiation of RCP light. If these conductivities include the spin current operator,

TABLE II. Shift- and injection-current conductivities for monolayer NbSe<sub>2</sub> under irradiation of LP and CP light.

	$\sigma_{ijk}^{\text{shift}}(0; \omega, -\omega)$	$\sigma_{ijk}^{\text{spin-shift}}(0; \omega, -\omega)$	$\sigma_{ijk}^{\text{injection}}(0; \omega, -\omega)$	$\sigma_{ijk}^{\text{spin-injection}}(0; \omega, -\omega)$
$ijk = xxx$	0	$\approx 10^0$	0	$\approx 10^2$ ( $\eta = 0.001$ eV)
$ijk = xyy, yxy, yyx$	0	$\approx -10^0$	0	$\approx -10^2$ ( $\eta = 0.001$ eV)
$ijk = yyy$	$\approx 10^1$	0	0	0
$ijk = yxx, xyx, xxy$	$\approx -10^1$	0	0	0
$ijk = xRL$	$\approx 10^1$	0	$\approx 10^1$ ( $\eta = 0.001$ eV)	0
$ijk = yRL$	0	$\approx 10^1$	0	0
$ijk = xLR$	$\approx -10^1$	0	$\approx -10^1$ ( $\eta = 0.001$ eV)	0
$ijk = yLR$	0	$\approx -10^1$	0	0

Eqs. (29) and (30) are rewritten as spin-dependent shift- and injection-current conductivities. Here,  $R_{nm}^i(\mathbf{k})$  and  $\Delta_{nm}^i(\mathbf{k})$  includes the charge and spin operators.

For RCP light, the finite elements of charge and spin shift-current conductivities are  $\sigma_{xRL}^{\text{shift}}(0; \omega, -\omega)$  and  $\sigma_{yRL}^{\text{spin-shift}}(0; \omega, -\omega)$ . For LCP light, the charge and spin shift-current conductivities have opposite sign to those of RCP light, i.e.,

$$\begin{aligned} \sigma_{xLR}^{\text{shift}}(0; \omega, -\omega) &= -\sigma_{xRL}^{\text{shift}}(0; \omega, -\omega), \\ \sigma_{yLR}^{\text{spin-shift}}(0; \omega, -\omega) &= -\sigma_{yRL}^{\text{spin-shift}}(0; \omega, -\omega). \end{aligned} \quad (32)$$

The other elements are absent for monolayer NbSe<sub>2</sub>.

Figure 5 (d) shows the charge and spin shift-current conductivities for monolayer NbSe<sub>2</sub> under irradiation of CP light. Because of the broken inversion symmetry, the charge shift current can be generated in  $x$ -direction for CP light. On the other hand, the spin shift current can be generated in  $y$ -direction for CP light. Comparing the results of CP light with those of LP light, the directions of generated charge and spin shift current are switched for monolayer NbSe<sub>2</sub>: the charge shift current is generated in  $y$ -direction for LP light, but in  $x$ -direction for CP light. For spin shift current, the irradiation of LP and CP light causes the generation in  $x$ - and  $y$ -directions, respectively. Thus, the direction of generated shift current can be switched if LP light is altered to CP light.

For CP light, the charge injection-current conductivities  $\sigma_{xRL}^{\text{injection}}(0; \omega, -\omega)$  and  $\sigma_{xLR}^{\text{injection}}(0; \omega, -\omega)$  are finite for monolayer NbSe<sub>2</sub>, in further the relation of these finite conductivities is given as

$$\sigma_{xRL}^{\text{injection}}(0; \omega, -\omega) = -\sigma_{xLR}^{\text{injection}}(0; \omega, -\omega). \quad (33)$$

The other elements are absent for monolayer NbSe<sub>2</sub>.

Figure 5 (e) shows the charge injection-current conductivities for monolayer NbSe<sub>2</sub> under irradiation of CP light. Owing to the broken inversion symmetry, the charge injection current can be generated in  $x$ -direction for CP light. As shown in Fig. 5 (f), the magnitude of injection-current conductivity becomes larger with the increase of  $\tau$ , but that of shift-current conductivity is robust owing to its topological properties. It is found that the generated injection current for CP light irradiation has stronger  $\tau$ -dependence than that of LP light.

$\Omega_{mn}^{xy}(\mathbf{k})$ ,  $R_{nm}^i(\mathbf{k})$  and  $\Delta_{nm}^i(\mathbf{k})$  of the integrands in Eqs. (29) and (30) are shown in Appendix E. Since the products are even

for  $\pi$ -rotation, where  $\Omega_{mn}^{xy}(\mathbf{k})$ ,  $R_{nm}^i(\mathbf{k})$  and  $\Delta_{nm}^i(\mathbf{k})$  are odd, the shift and injection current can be generated for monolayer NbSe<sub>2</sub>. However, when the products are odd for  $\pi$ -rotation, the current is absent.

### C. Selection rule by polarization

The selection rules of shift- and injection-current conductivities by light polarization are summarized in Table II. Figures 6 (a) and (b) show the schematics of generated shift current in monolayer NbSe<sub>2</sub> under irradiation of LP light. For  $y$ -polarized light, the charge and spin shift current can be generated in  $y$ - and  $x$ -directions. On the other hand, for  $x$ -polarized light, the charge and spin shift current are generated in  $y$ - and  $x$ -directions, respectively.

For CP light irradiation, the charge and spin shift current can be generated in  $x$ - and  $y$ -directions as shown in Figs 6 (c) and (d). Thus, the directions of generated charge and spin shift current are switched when the polarization of incident light is altered from LP to CP.

## VI. SUMMARY

In summary, we have theoretically studied the second-order NLO charge and spin current in the metallic TMDCs. As a example of metallic TMDCs, we have employed few-layered NbSe<sub>2</sub>, which possesses the Ising-type SOC. For odd-number-layered NbSe<sub>2</sub>, the inversion symmetry is broken, however, the inversion symmetry is preserved for even-number-layered NbSe<sub>2</sub>. It is pointed out that the second-order NLO charge and spin current in the metallic TMDCs strongly depends on their crystal symmetry of system and polarization of incident light. The NLO current is finite for odd-number-layered NbSe<sub>2</sub>, but absent for even-number-layered NbSe<sub>2</sub>.

Since BCL can control the symmetry of electronic system, NLO charge and spin current can be induced along the directions of leaves of BCL. Thus, under irradiation of BCL, the NLO current can be generated in not only odd-number-layered, but also even-number-layered NbSe<sub>2</sub>. For even-number-layered NbSe<sub>2</sub>, the peaks appear in low energy range, which cause the infrared light absorption. Such infrared light absorption is absent in semiconductor TMDC owing to the

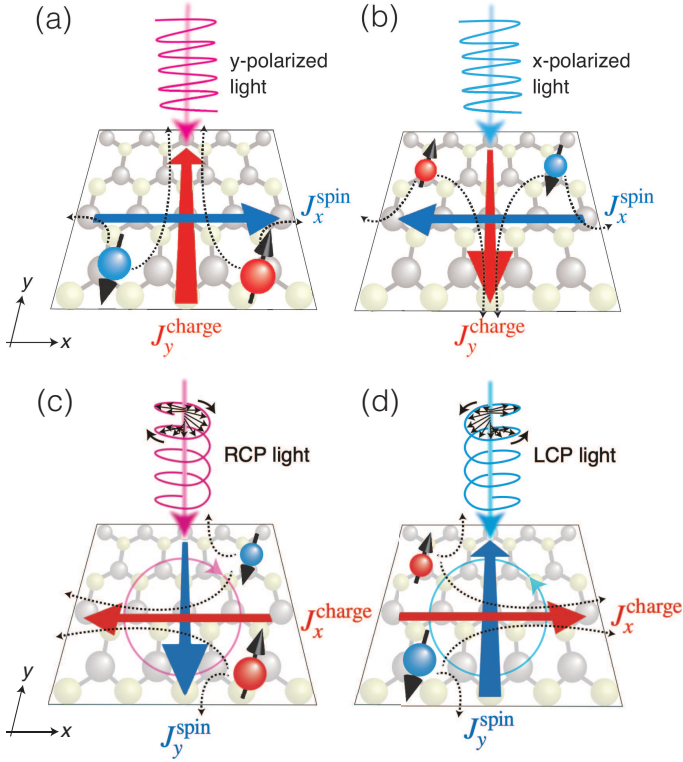

FIG. 6. Schematics of generated charge and spin shift current for (a) y-polarized light and (b) x-polarized light in monolayer NbSe<sub>2</sub>. For (c) RCP and (d) LCP light, generation of charge and spin shift current is caused in monolayer NbSe<sub>2</sub>.

energy band gap around Fermi level.

In further, we have shown that shift and injection current can be generated in odd-number-layered NbSe<sub>2</sub> under irradiation of LP and CP light. The topological shift current is robust to electron scattering of system, but the injection current strongly depends on the scattering. The generated shift current can be switched if LP light is altered to CP light.

In Supplementary Material, the second-order NLO current can be generated even in MoS<sub>2</sub> as a reference of TMDC semiconductors [63]. Thus, TMDCs such as NbSe<sub>2</sub> and MoS<sub>2</sub> can be used for the source of second-order NLO charge and spin current. Our results can serve to design spin current harvesting and opt-spintronics devices on the basis of 2D materials.

#### ACKNOWLEDGMENTS

This work was supported by JSPS KAKENHI (Nos. 22H05473, JP21H01019, JP18H01154) and JST CREST (No. JPMJCR19T1).

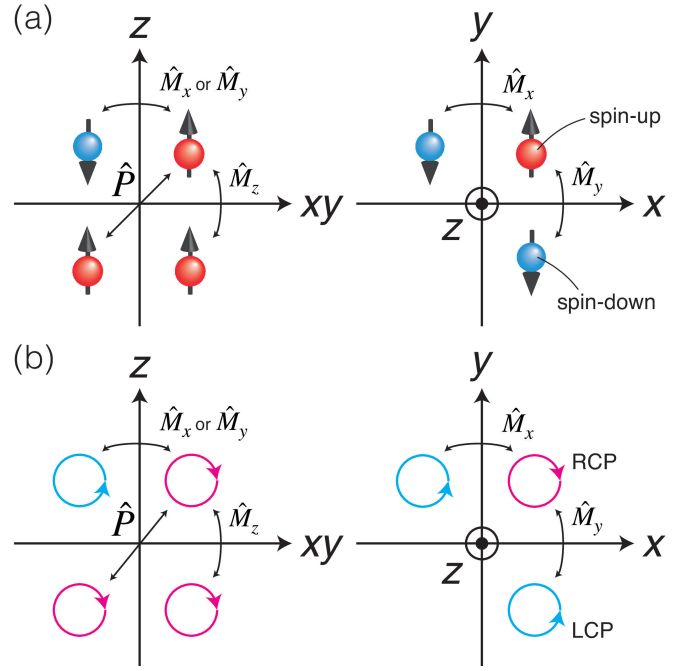

FIG. 7. Symmetric operator for an axial vector. Schematics of mirror and inversion symmetry operations  $\hat{M}_x$ ,  $\hat{M}_y$ ,  $\hat{M}_z$  and  $\hat{P}$  for (a) spin-up (red) and spin-down (blue) states  $s_z = \pm \frac{\hbar}{2}$  and (b) electric fields of RCP (magenta) and LCP (cyan) light.

#### Appendix A: Crystal symmetry and the second-order NLO conductivity

The second-order NLO conductivity strongly depends on the crystal symmetry [28, 62]. Table I shows that the NLO charge and spin conductivities of SHG process are finite for odd-number-layered NbSe<sub>2</sub>, but absent for even-number-layered NbSe<sub>2</sub>. The finite NLO conductivities are attributed to the broken inversion symmetry. In this section, we discuss general NLO conductivities by considering the crystal symmetry of system, which are consistent with the numerical results.

Even-number-layered NbSe<sub>2</sub> has the inversion symmetric operator  $\hat{P} = \hat{M}_x \hat{M}_y \hat{M}_z$ . Here, the  $3 \times 3$  matrices of  $\hat{M}_x$ ,  $\hat{M}_y$  and  $\hat{M}_z$  are expressed as

$$\hat{M}_x = \begin{pmatrix} -1 & 0 & 0 \\ 0 & 1 & 0 \\ 0 & 0 & 1 \end{pmatrix}, \quad \hat{M}_y = \begin{pmatrix} 1 & 0 & 0 \\ 0 & -1 & 0 \\ 0 & 0 & 1 \end{pmatrix}, \quad \hat{M}_z = \begin{pmatrix} 1 & 0 & 0 \\ 0 & 1 & 0 \\ 0 & 0 & -1 \end{pmatrix}.$$

Because of the inversion symmetry  $P$ , position operator  $\hat{r}$ , momentum operator  $\hat{p}$  and spin operator  $\hat{s} = \frac{\hbar}{2}(\hat{\sigma}_x, \hat{\sigma}_y, \hat{\sigma}_z)$  have the following properties:

$$\hat{P}\hat{r} = -\hat{r}, \quad \hat{P}\hat{p} = -\hat{p}, \quad \hat{P}\hat{s} = \hat{s}. \quad (\text{A1})$$

The charge current density  $J_i^{\text{charge}}$  and  $j$ - and  $k$ -elements of incident electric fields  $E_j(\omega_1)$  and  $E_k(\omega_2)$  after the operation

of  $\hat{P}$  become

$$J_i^{\text{charge}} \xrightarrow{\hat{P}} \tilde{J}_i^{\text{charge}} = -J_i^{\text{charge}},$$

$$E_j(\omega_1)E_k(\omega_2) \xrightarrow{\hat{P}} \tilde{E}_j(\omega_1)\tilde{E}_k(\omega_2) = (-1)^2 E_j(\omega_1)E_k(\omega_2),$$

where  $i$  is the propagation of charge current ( $i = x, y, z$ ) and  $(j, k)$  are the polarizations of incident light. Note that  $\tilde{A}$  means the arbitrary physical quantity  $A$  after the symmetry operation. For second-order NLO response,  $J_i^{\text{charge}}$  is proportional to  $E_j(\omega_1)E_k(\omega_2)$ , which given as

$$J_i^{\text{charge}} = \sigma_{ijk}^{\text{charge}}(\omega_1 + \omega_2; \omega_1, \omega_2) E_j(\omega_1) E_k(\omega_2). \quad (\text{A2})$$

Comparing the current and electric fields before and after  $\hat{P}$  operation, the NLO conductivities become

$$\sigma_{ijk}^{\text{charge}}(\omega_1 + \omega_2; \omega_1, \omega_2) = -\sigma_{ijk}^{\text{charge}}(\omega_1 + \omega_2; \omega_1, \omega_2).$$

Thus, in even-number-layered NbSe<sub>2</sub>, the NLO charge conductivity  $\sigma_{ijk}^{\text{charge}}(\omega_1 + \omega_2; \omega_1, \omega_2)$  is absent for all combinations of  $ijk$ .

The spin current density  $J_i^{\text{spin}}$  is given as

$$J_i^{\text{spin}} = \sigma_{ijk}^{\text{spin}}(\omega_1 + \omega_2; \omega_1, \omega_2) E_j(\omega_1) E_k(\omega_2). \quad (\text{A3})$$

As seen in Fig. 7 (a), in even-number-layered NbSe<sub>2</sub>, the spin state is invariant after  $\hat{P}$ . Thus,  $J_i^{\text{spin}}$  after  $\hat{P}$  becomes

$$J_i^{\text{spin}} \xrightarrow{\hat{P}} \tilde{J}_i^{\text{spin}} = -J_i^{\text{spin}},$$

which causes the absence of NLO spin conductivity  $\sigma_{ijk}^{\text{spin}}(\omega_1 + \omega_2; \omega_1, \omega_2)$  for even-number-layered NbSe<sub>2</sub>. These results are consistent with the numerical calculations shown in Table I.

In odd-number-layered NbSe<sub>2</sub>, where  $P$  is broken, the system has the mirror symmetry  $M_x M_z$ .  $J_i^{\text{charge}}$  and  $E_j(\omega_1), E_k(\omega_2)$  after the mirror symmetry operation  $\hat{M}_x \hat{M}_z$  become

$$J_i^{\text{charge}} \xrightarrow{\hat{M}_x \hat{M}_z} \tilde{J}_i^{\text{charge}} = (-1)^{\delta_{ix} + \delta_{iz}} J_i^{\text{charge}},$$

$$E_j(\omega_1) \xrightarrow{\hat{M}_x \hat{M}_z} \tilde{E}_j(\omega_1) = (-1)^{\delta_{jx} + \delta_{jz}} E_j(\omega_1),$$

$$E_k(\omega_2) \xrightarrow{\hat{M}_x \hat{M}_z} \tilde{E}_k(\omega_2) = (-1)^{\delta_{kx} + \delta_{kz}} E_k(\omega_2),$$

where  $\delta_{ix}$  is Kronecker delta:

$$\delta_{ix} = \begin{cases} 1 & (i = x) \\ 0 & (i \neq x) \end{cases}. \quad (\text{A4})$$

Thus,  $\hat{M}_x \hat{M}_z$  makes the following  $ijk$ -elements of  $\sigma_{ijk}^{\text{charge}}(\omega_1 + \omega_2; \omega_1, \omega_2)$  in Eq. (A2) finite, i.e.,  $ijk = xxy, xyx, xyx, xzy, yxx, yxz, yyy, yzx, yzz, zxy, yxz, zyx, zzy$ . The other elements are absent for odd-number-layered

NbSe<sub>2</sub>. In addition, the system has 3-fold rotation symmetry operation  $\hat{C}_3$ , which is given as

$$\hat{C}_3 = \begin{pmatrix} -\frac{1}{2} & \frac{\sqrt{3}}{2} & 0 \\ -\frac{\sqrt{3}}{2} & -\frac{1}{2} & 0 \\ 0 & 0 & 1 \end{pmatrix}.$$

Owing to  $\hat{C}_3$ , the finite NLO charge conductivities have a relation for odd-number-layered NbSe<sub>2</sub>, i.e.,

$$\sigma_{yyy}^{\text{charge}}(\omega_1 + \omega_2; \omega_1, \omega_2) = -\sigma_{xxy}^{\text{charge}}(\omega_1 + \omega_2; \omega_1, \omega_2)$$

$$= -\sigma_{xyx}^{\text{charge}}(\omega_1 + \omega_2; \omega_1, \omega_2) = -\sigma_{yxx}^{\text{charge}}(\omega_1 + \omega_2; \omega_1, \omega_2). \quad (\text{A5})$$

In Fig. 7 (a), the spin state becomes opposite after  $\hat{M}_x \hat{M}_z$ , which causes

$$J_i^{\text{spin}} \xrightarrow{\hat{M}_x \hat{M}_z} \tilde{J}_i^{\text{spin}} = -(-1)^{\delta_{ix} + \delta_{iz}} J_i^{\text{spin}}.$$

Thus, the following  $ijk$ -elements of  $\sigma_{ijk}^{\text{spin}}(\omega_1 + \omega_2; \omega_1, \omega_2)$  in Eq. (A3) are finite for odd-number-layered NbSe<sub>2</sub>:  $ijk = xxx, xxz, xyy, xzx, xzz, yxy, yyx, yyz, yzy, zxx, zxz, zyy, zzx, zzz$ .

The other elements are absent. Also, for odd-number-layered NbSe<sub>2</sub>, the following relation of  $\sigma_{ijk}^{\text{spin}}(\omega_1 + \omega_2; \omega_1, \omega_2)$  is obtained after  $\hat{C}_3$ , i.e.,

$$\sigma_{xxx}^{\text{spin}}(\omega_1 + \omega_2; \omega_1, \omega_2) = -\sigma_{xyy}^{\text{spin}}(\omega_1 + \omega_2; \omega_1, \omega_2)$$

$$= -\sigma_{yxx}^{\text{spin}}(\omega_1 + \omega_2; \omega_1, \omega_2) = -\sigma_{yzz}^{\text{spin}}(\omega_1 + \omega_2; \omega_1, \omega_2). \quad (\text{A6})$$

These results indicate that spin current can be generated in odd-number-layered NbSe<sub>2</sub> when charge current is absent. When  $\omega_1 = \omega_2 \equiv \omega \neq 0$ , the analytic results are consistent with the numerical results of SHG process shown in Table I.

Next, by considering the crystal symmetry, we shall discuss the generation of NLO charge and spin current in NbSe<sub>2</sub> under CP light irradiation. For CP light,  $J_i^{\text{charge}}$  is given as

$$J_i^{\text{charge}} = \sigma_{iRL}^{\text{charge}}(\omega_1 + \omega_2; \omega_1, \omega_2) E_R(\omega_1) E_L(\omega_2). \quad (\text{A7})$$

For even-number-layered NbSe<sub>2</sub>, the product of electric fields of CP light  $E_R(\omega_1)E_L(\omega_2)$  after  $\hat{P}$  becomes

$$E_R(\omega_1)E_L(\omega_2) \xrightarrow{\hat{P}} \tilde{E}_R(\omega_1)\tilde{E}_L(\omega_2) = E_R(\omega_1)E_L(\omega_2),$$

where as shown in Fig. 7 (b),  $E_R(\omega_1), E_L(\omega_2)$  are invariant for  $\hat{P}$ . Comparing the current and the electric fields of incident light before and after  $\hat{P}$ ,  $\sigma_{iRL}^{\text{charge}}(\omega_1 + \omega_2; \omega_1, \omega_2)$  becomes zero. Since  $J_i^{\text{spin}}$  is invariant after  $\hat{P}$ ,  $\sigma_{iRL}^{\text{spin}}(\omega_1 + \omega_2; \omega_1, \omega_2)$  is absent as same as NLO charge conductivity.

In odd-number-layered NbSe<sub>2</sub>,  $E_R(\omega_1)E_L(\omega_2)$  after  $\hat{M}_x \hat{M}_z$  becomes

$$E_R(\omega_1)E_L(\omega_2) \xrightarrow{\hat{M}_x \hat{M}_z} \tilde{E}_R(\omega_1)\tilde{E}_L(\omega_2) = E_L(\omega_1)E_R(\omega_2).$$

Thus,  $\hat{M}_x\hat{M}_z$  makes  $\sigma_{xRL}^{\text{charge}}(\omega_1 + \omega_2; \omega_1, \omega_2)$  and  $\sigma_{zRL}^{\text{charge}}(\omega_1 + \omega_2; \omega_1, \omega_2)$  finite, but  $\sigma_{yRL}^{\text{charge}}(\omega_1 + \omega_2; \omega_1, \omega_2)$  is absent. Since the spin state becomes opposite owing to  $\hat{M}_x\hat{M}_z$ , the NLO spin conductivity  $\sigma_{yRL}^{\text{spin}}(\omega_1 + \omega_2; \omega_1, \omega_2)$  is finite, but the other elements are absent. These results are consistent with the numerical calculation summarized in Table II.

In further, under irradiation of BCL ( $A_{\text{BCL}}(t) = A_L e^{in_1\omega t} + A_R e^{in_2\omega t - i\theta} + \text{c.c.}$ ), the mirror symmetry  $M_x$  is broken. Thus,  $\hat{M}_y\hat{M}_z$  remains in the electronic system.  $J_i^{\text{charge}}$  and  $E_{\text{BCL}}(t)$  after  $\hat{M}_y\hat{M}_z$  become

$$J_i^{\text{charge}} \xrightarrow{\hat{M}_y\hat{M}_z} \tilde{J}_i^{\text{charge}} = (-1)^{\delta_y + \delta_z} J_i^{\text{charge}},$$

$$E_{\text{BCL}}(t) \xrightarrow{\hat{M}_y\hat{M}_z} \tilde{E}_{\text{BCL}}(t) = E_{\text{BCL}}(t).$$

Comparing the current and the electric field of incident light before and after  $\hat{M}_y\hat{M}_z$ , the NLO charge conductivity  $\sigma_{x\text{-BCL-BCL}}^{\text{charge}}(n_1\omega, n_2\omega)$  becomes finite. However, the other elements are absent for even-number-layered NbSe<sub>2</sub>. As seen in Fig. 7 (a), for  $\hat{M}_y\hat{M}_z$ , the spin state becomes opposite. Thus,  $\sigma_{y\text{-BCL-BCL}}^{\text{spin}}(n_1\omega, n_2\omega)$  and  $\sigma_{z\text{-BCL-BCL}}^{\text{spin}}(n_1\omega, n_2\omega)$  are finite, but  $\sigma_{x\text{-BCL-BCL}}^{\text{spin}}(n_1\omega, n_2\omega)$  is absent. These analytic results show that thanks to incident BCL, the NLO charge and spin current can be generated even in even-number-layered NbSe<sub>2</sub>.

Odd-number-layered NbSe<sub>2</sub> has  $M_xM_z$ . Since  $M_x$  is broken under BCL irradiation, the electronic system has  $\hat{M}_z$ . For  $\hat{M}_z$ ,  $J_i^{\text{charge}}$  and  $E_{\text{BCL}}(t)$  become

$$J_i^{\text{charge}} \xrightarrow{\hat{M}_z} \tilde{J}_i^{\text{charge}} = (-1)^{\delta_z} J_i^{\text{charge}},$$

$$E_{\text{BCL}}(t) \xrightarrow{\hat{M}_z} \tilde{E}_{\text{BCL}}(t) = E_{\text{BCL}}(t).$$

Owing to the comparison between the generated current and incident light before and after  $\hat{M}_z$ ,  $\sigma_{x\text{-BCL-BCL}}^{\text{charge}}(n_1\omega, n_2\omega)$  and  $\sigma_{y\text{-BCL-BCL}}^{\text{charge}}(n_1\omega, n_2\omega)$  become finite for odd-number-layered NbSe<sub>2</sub>, but  $\sigma_{z\text{-BCL-BCL}}^{\text{charge}}(n_1\omega, n_2\omega)$  is absent. Since the spin state is invariant after  $\hat{M}_z$ ,  $\sigma_{x\text{-BCL-BCL}}^{\text{spin}}(n_1\omega, n_2\omega)$  and  $\sigma_{y\text{-BCL-BCL}}^{\text{spin}}(n_1\omega, n_2\omega)$  are finite, but  $\sigma_{z\text{-BCL-BCL}}^{\text{spin}}(n_1\omega, n_2\omega)$  is absent.

### Appendix B: NLO charge and spin conductivities for irradiation of BCL with multi-leaves

In this section, we consider BCL of 4-, 5-, 6- and 7-leaf with  $\theta = 0$  in Eq. (12). Figure 8 (a) shows the trajectories of these incident BCL. Figures 8 (b), (c), (d) and (e) show the NLO charge and spin conductivities for monolayer NbSe<sub>2</sub> with SOC under irradiation of BCL. Since the BCL can control the symmetry of electronic system, these NLO charge and spin conductivities are finite for monolayer NbSe<sub>2</sub>, which are similar to the results of BCL with 3-leaf ( $n_1 : n_2 = 1 : 2$ ). Thus, unlike the irradiation of LP light, the NLO charge and spin

current is generated in both  $x$ - and  $y$ -directions along the induced polarizations by irradiating BCL.

We should note that the peaks of the NLO charge and spin conductivities shift lower with increase of leaves of BCL. The shift originates from the denominator  $E_{mn} - (n_1 + n_2)\hbar\omega - i\eta$  in Eq. (9). With increase of  $(n_1 + n_2)$ , the denominator  $E_{mn} - (n_1 + n_2)\hbar\omega - i\eta$  becomes smaller, thus the shift occurs.

### Appendix C: Finite conductivity for CP light with different optical angular frequency

The shift current under irradiation of CP light contains the product of Berry curvature  $\Omega_{mn}^{xy}(\mathbf{k})$  and shift vector  $R_{nm}^i(\mathbf{k})$  as shown in Eq. (29). The Berry curvatures between RCP and LCP light are antisymmetric, thus the shift current for irradiation of RCP and LCP light is generated in opposite directions.

When the optical angular frequencies of RCP and LCP light are same, as shown in Fig. 9 (a), the cancellation of generated shift current occurs for RCP and LCP light, i.e., absence of current [42, 80, 81]. Figure 9 (b) shows the schematics of shift current under the irradiation of LCP light with  $2n_1\omega$  and RCP light with  $2n_2\omega$ . If LCP and RCP light has the different optical angular frequencies, i.e.,  $n_1 \neq n_2$ , the amounts of shifts for photoexcited electrons under irradiation of LCP and RCP light are not same, i.e., no cancellation of shift current.

In Eq. (13), the NLO conductivity for BCL irradiation is rewritten as the summation of conductivities for different four combinations of CP light, i.e., ‘LL’, ‘LR’, ‘RL’, ‘RR’. Owing to the irradiation of CP light with different optical angular frequencies, the first and fourth terms are finite, but other terms are cancelled. Thus, for irradiation of BCL, the second-order NLO current is generated even in even-number-layered NbSe<sub>2</sub>.

### Appendix D: NLO charge and spin current in trilayer NbSe<sub>2</sub> under irradiation of BCL

As shown in Fig. 10 (a), we consider  $n_1 : n_2 = 1 : 2$  and  $\theta = 0$  for BCL with 3-leaf. Figure 10 (b) shows the NLO charge and spin conductivities for trilayer NbSe<sub>2</sub> under irradiation of the BCL. Since the BCL breaks the mirror symmetry with respect to  $y-z$  plane, these NLO charge and spin conductivities are finite for trilayer NbSe<sub>2</sub>. Here, it should be noted that the peaks of the NLO conductivities appear around  $\hbar\omega = 0.01$  eV shown by yellow squares. The appearance of peaks occurs owing to the photoexcitation between the nearest valence and conduction bands of trilayer NbSe<sub>2</sub> as shown in Fig. 10 (c), which causes infrared light absorption.

In further, for trilayer NbSe<sub>2</sub>, the NLO conductivities under irradiation of 3-leaf BCL consist of three optical transition processes: (i) intralayer optical transition of monolayer NbSe<sub>2</sub>, (ii) intra- and interlayer optical transitions of bilayer NbSe<sub>2</sub> and (iii) interlayer optical transition between monolayer and bilayer NbSe<sub>2</sub>. For irradiation of LP light, the process (ii) is absent [62], however BCL with 3-leaf makes all three processes finite.

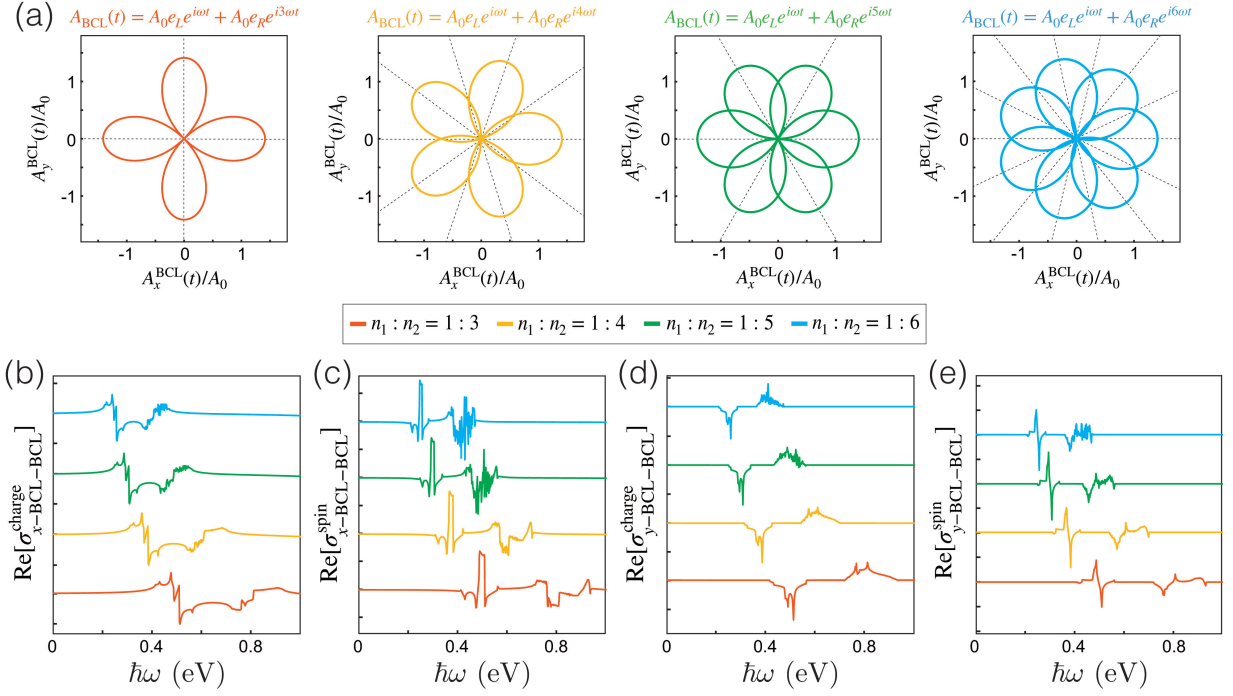

FIG. 8. (a) Trajectories of BCL with 4-, 5-, 6- and 7-leaf. Real parts of NLO charge and spin conductivities (b)  $\sigma_{x-\text{BCL-BCL}}^{\text{charge}}$ , (c)  $\sigma_{x-\text{BCL-BCL}}^{\text{spin}}$ , (d)  $\sigma_{y-\text{BCL-BCL}}^{\text{charge}}$  and (e)  $\sigma_{y-\text{BCL-BCL}}^{\text{spin}}$  for monolayer NbSe<sub>2</sub> with SOC under irradiation of BCL. Orange, yellow, green and blue lines indicate NLO conductivities for BCL with 4-, 5-, 6- and 7-leaf. The units of NLO charge and spin conductivities are  $e^3/\hbar$  and  $e^2$ , respectively.

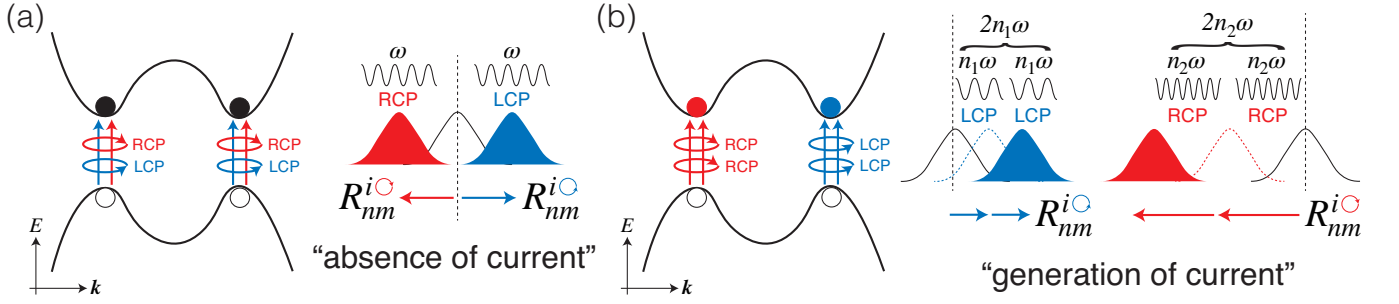

FIG. 9. Schematics of photoexcitation for CP light irradiation and corresponding shift vectors. (a) For irradiation of RCP (red) and LCP (blue) light with same optical angular frequency  $\omega$ , RCP and LCP make same amount of shift but opposite direction, i.e., absence of current. (b) For irradiation of RCP and LCP light with different optical angular frequencies  $n_1\omega \neq n_2\omega$ , the amount of shifts by RCP and LCP is different and no cancellation, i.e., generation of current.

#### Appendix E: Contour plots of $\alpha_{mn}^{jk}(\mathbf{k})$ , $R_{nm}^i(\mathbf{k})$ , $\Delta_{mn}^i(\mathbf{k})$ , $\Omega_{mn}^{jk}(\mathbf{k})$

We discuss the origin of finite shift and injection current by considering the contour plots of transition intensity  $\alpha_{mn}^{jk}(\mathbf{k})$ , shift vector  $R_{nm}^i(\mathbf{k})$ , velocity difference between electron and hole  $\Delta_{mn}^i(\mathbf{k})$ , and Berry curvature  $\Omega_{mn}^{jk}(\mathbf{k})$ . All these factors appear as the integrand of the conductivities. For simplicity, we shall focus on the results of monolayer NbSe<sub>2</sub>, because other cases such bi- and trilayer NbSe<sub>2</sub> are similar.

In Eq. (23), the charge (spin) shift-current conductivity for LP light contains the product  $\alpha_{mn}^{jk}(\mathbf{k})R_{nm}^i(\mathbf{k})$

( $\alpha_{mn}^{jk}(\mathbf{k})R_{nm}^{i-\text{spin}}(\mathbf{k})$ ). If the product  $\alpha_{mn}^{jk}(\mathbf{k})R_{nm}^i(\mathbf{k})$  is even with respect to  $\pi$ -rotation, the shift-current conductivities become finite. According to the contour plots of transition intensity shown in Fig. 11 (a),  $\alpha_{mn}^{jk}(\mathbf{k})$  with  $jk = xx, yy$  is even for  $\pi$ -rotation. Similarly, as shown in Fig. 11 (b), the shift vectors  $R_{nm}^i(\mathbf{k})$  and  $R_{nm}^{i-\text{spin}}(\mathbf{k})$  are also even for  $\pi$ -rotation. Therefore, the charge and spin shift current are generated in  $y$ - and  $x$ -directions, respectively. The remaining elements  $R_{nm}^x(\mathbf{k})$  and  $R_{nm}^{y-\text{spin}}(\mathbf{k})$  are odd for  $\pi$ -rotation, i.e., the absence of shift current.

In Eq. (25), the charge (spin) injection-current conductivity

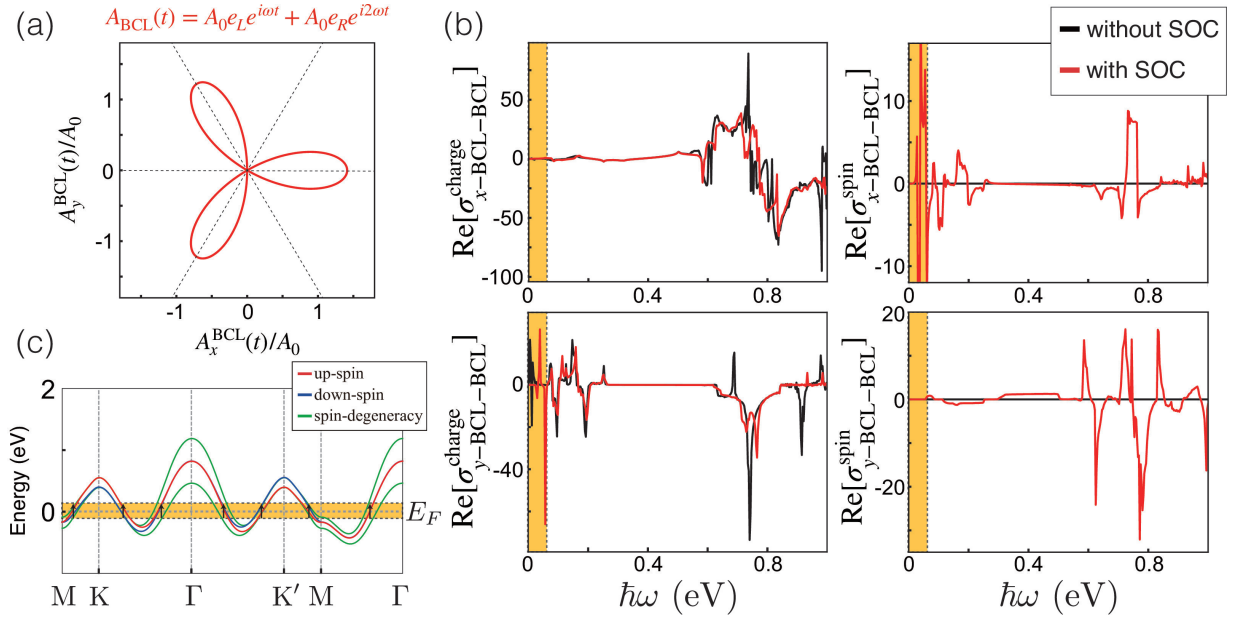

FIG. 10. (a) Trajectory of BCL with 3-leaf ( $n_1 : n_2 = 1 : 2$ ). (b) Real parts of NLO charge and spin conductivities  $\sigma_{x\text{-BCL-BCL}}^{\text{charge}}$ ,  $\sigma_{x\text{-BCL-BCL}}^{\text{spin}}$ ,  $\sigma_{y\text{-BCL-BCL}}^{\text{charge}}$  and  $\sigma_{y\text{-BCL-BCL}}^{\text{spin}}$  for trilayer NbSe<sub>2</sub>. Black and red lines indicate NLO conductivities without and with SOC. The units of NLO charge and spin conductivities are  $e^3/\hbar$  and  $e^2$ , respectively. (c) Energy band structure of trilayer NbSe<sub>2</sub> and the interband optical transition between nearest valence and conduction bands around Fermi energy  $E_F = 0$  eV (shown by a yellow square).

ity for LP light contains  $\alpha_{mn}^{jk}(\mathbf{k})\Delta_{mn}^i(\mathbf{k})$  ( $\alpha_{mn}^{jk}(\mathbf{k})\Delta_{mn}^{i\text{-spin}}(\mathbf{k})$ ). Since  $\alpha_{mn}^{jk}(\mathbf{k})$  with  $jk = xx, yy$  is even with respect to  $\pi$ -rotation, velocity difference  $\Delta_{mn}^i(\mathbf{k})$  should be even in order to generate the injection current. In actual, as shown in Fig. 11 (c),  $\Delta_{mn}^{x\text{-spin}}(\mathbf{k})$  has even parity. Thus, the spin injection current is generated in  $x$ -direction. The remaining elements of  $\Delta_{mn}^i(\mathbf{k})$  are odd, i.e., the absence of injection current.

Similarly, in Eqs. (29) and (30), the charge (spin) shift/injection-current conductivities for RCP light contain the products  $\Omega_{mn}^{xy}(\mathbf{k})R_{nm}^i(\mathbf{k})$  ( $\Omega_{mn}^{xy}(\mathbf{k})R_{nm}^{i\text{-spin}}(\mathbf{k})$ ) and

$\Omega_{mn}^{xy}(\mathbf{k})\Delta_{mn}^i(\mathbf{k})$  ( $\Omega_{mn}^{xy}(\mathbf{k})\Delta_{mn}^{i\text{-spin}}(\mathbf{k})$ ), respectively. When the products are even with respect to  $\pi$ -rotation, the shift and injection current is generated for RCP light. Figures 11 (d), (e) and (f) show the contour plots of Berry curvature, shift vector and velocity difference for monolayer NbSe<sub>2</sub> under RCP light irradiation. From Fig. 11 (d),  $\Omega_{mn}^{xy}(\mathbf{k})$  and  $\Omega_{mn}^{yx}(\mathbf{k})$  are odd for  $\pi$ -rotation. Since  $R_{nm}^x(\mathbf{k})$  and  $R_{nm}^{y\text{-spin}}(\mathbf{k})$  are odd parities, the charge and spin shift current is generated in  $x$ - and  $y$ -directions, respectively. Similarly, since  $\Delta_{mn}^x(\mathbf{k})$  is odd parity, the charge injection current is generated in  $x$ -direction.

- 
- [1] P. A. Franken, A. E. Hill, C. W. Peters, and G. Weinreich, Generation of Optical Harmonics, *Phys. Rev. Lett.* **7**, 118 (1961).  
 [2] N. Bloembergen, *Nonlinear Optics*, World Scientific, Singapore, ed. 4 (1996).  
 [3] R. W. Boyd, *Nonlinear Optics*, Academic Press, London, ed. 3 (2008).  
 [4] J. E. Sipe and A. I. Shkrebti, Second-order optical response in semiconductors, *Phys. Rev. B* **61**, 5337 (2000).  
 [5] X. Wen, Z. Gong, and D. Li, Nonlinear optics of two-dimensional transition metal dichalcogenides, *InfoMat* **1**, 317 (2019).  
 [6] M. L. Trolle, G. Seifert, and T. G. Pedersen, Theory of excitonic second-harmonic generation in monolayer MoS<sub>2</sub>, *Phys. Rev. B* **89**, 235410 (2014).  
 [7] N. Kumar, S. Najmaei, Q. Cui, F. Ceballos, P. M. Ajayan, J. Lou, and H. Zhao, Second harmonic microscopy of monolayer mos<sub>2</sub>, *Phys. Rev. B* **87**, 161403(R) (2013).  
 [8] D. J. Moss, J. E. Sipe, and H. M. van Driel, Empirical tight-binding calculation of dispersion in the second-order nonlinear optical constant for zinc-blende crystals, *Phys. Rev. B* **36**, 9708 (1987).  
 [9] E. Ghahramani, D. J. Moss, and J. E. Sipe, Full-band-structure calculation of second-harmonic generation in odd-period strained (Si)<sub>n</sub>/(Ge)<sub>n</sub> superlattices, *Phys. Rev. B* **43**, 8990 (1991).  
 [10] L. Malard, T. Alencar, A. Barboza, K. Mak, and A. dePaula, Observation of intense second harmonic generation from mos<sub>2</sub> atomic crystals, .  
 [11] K. L. Seyler, J. R. Schaibley, P. Gong, P. Rivera, A. M. Jones, S. Wu, J. Yan, D. G. Mandrus, W. Yao, and X. Xu, Electrical control of second-harmonic generation in a WSe<sub>2</sub> monolayer transistor, *Nat. Nanotech.* **10**, 407 (2015).  
 [12] S. N. Rashkeev, W. R. L. Lambrecht, and B. Segall, Efficient *ab initio* method for the calculation of frequency-dependent



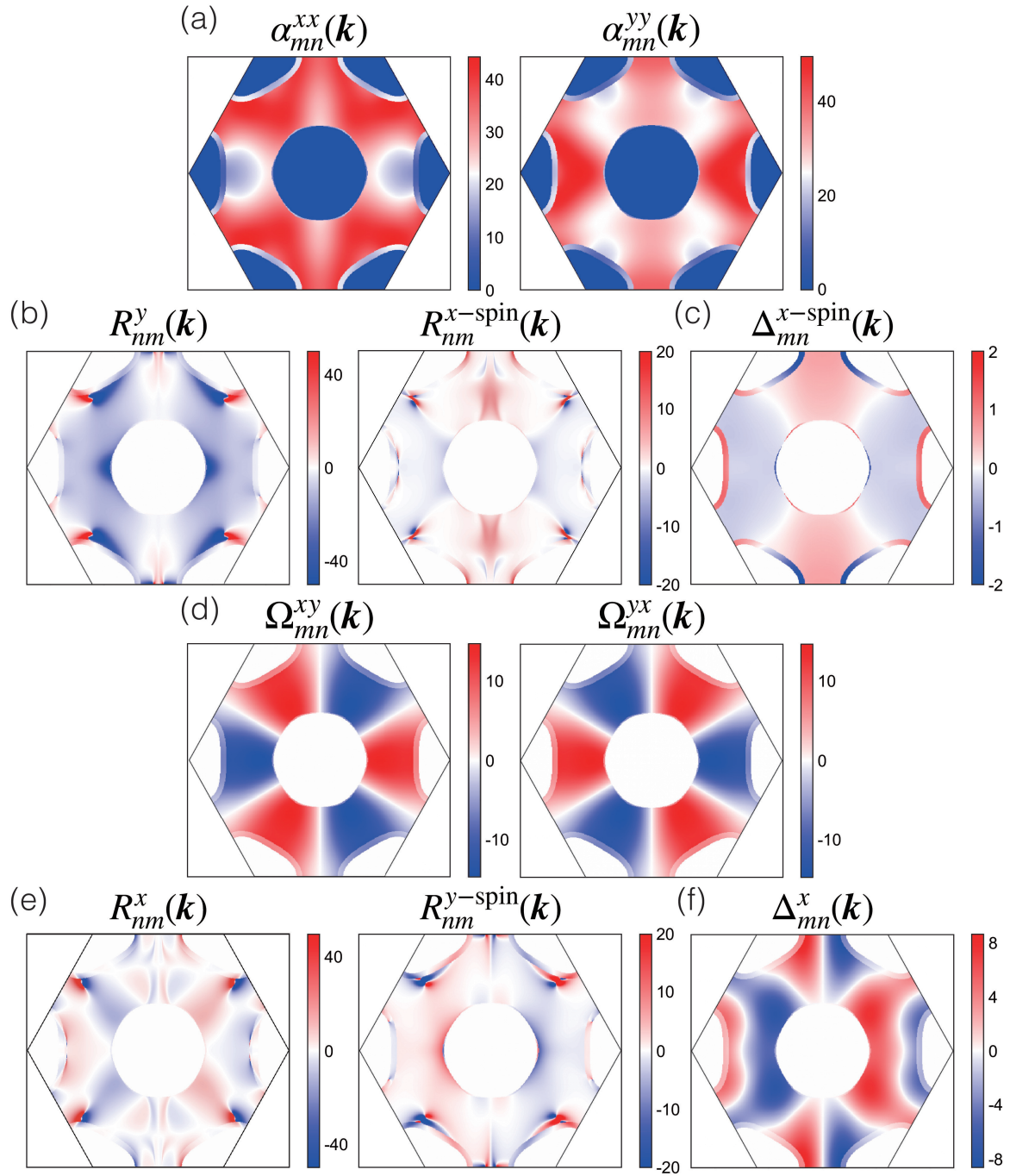

FIG. 11. Contour plots of shift- and injection-current conductivity components: (a) transition intensities  $\alpha_{mn}^{xx}(\mathbf{k})$  and  $\alpha_{mn}^{yy}(\mathbf{k})$ , (b, e) shift vectors  $R_{nm}^y(\mathbf{k})$ ,  $R_{nm}^{x\text{-spin}}(\mathbf{k})$ ,  $R_{nm}^x(\mathbf{k})$  and  $R_{nm}^{y\text{-spin}}(\mathbf{k})$ , (c, f) velocity difference between electron and hole  $\Delta_{mn}^{x\text{-spin}}(\mathbf{k})$  and  $\Delta_{mn}^x(\mathbf{k})$ , and (d) Berry curvatures  $\Omega_{mn}^{xy}(\mathbf{k})$  and  $\Omega_{mn}^{yx}(\mathbf{k})$ , respectively.

- second-order optical response in semiconductors, Phys. Rev. B **57**, 3905 (1998).
- [13] S. N. Rashkeev and W. R. L. Lambrecht, Second-harmonic generation of I-III-VI<sub>2</sub> chalcopyrite semiconductors: Effects of chemical substitutions, Phys. Rev. B **63**, 165212 (2001).
- [14] S. Sharma and C. Ambrosch-Draxl, Second-Harmonic Optical Response from First Principles, Phys. Scr. **T109**, 128 (2004).
- [15] R. Leitsmann, W. G. Schmidt, P. H. Hahn, and F. Bechstedt, Second-harmonic polarizability including electron-hole attraction from band-structure theory, Phys. Rev. B **71**, 195209 (2005).
- [16] Y. R. Shen, Surface properties probed by second-harmonic and sum-frequency generation, Nature **337**, 519 (1989).
- [17] Y. R. Shen, Revisiting the basic theory of sum-frequency gen-

- eration, *J. Chem. Phys.* **153**, 180901 (2020).
- [18] T. Ishiyama, T. Imamura, and A. Morita, Theoretical Studies of Structures and Vibrational Sum Frequency Generation Spectra at Aqueous Interfaces, *Chem. Rev.* **114**, 8447 (2014).
- [19] C. Stock, K. Zlatanov, and T. Halfmann, Third harmonic generation and microscopy, enhanced by a bias harmonic field, *Opt. Commun.* **457**, 124660 (2020).
- [20] C. Winterfeldt, C. Spielmann, and G. Gerber, Colloquium: Optimal control of high-harmonic generation, *Rev. Mod. Phys.* **80**, 117 (2008).
- [21] G. Vampa, C. R. McDonald, G. Orlando, D. D. Klug, P. B. Corkum, and T. Brabec, Theoretical Analysis of High-Harmonic Generation in Solids, *Phys. Rev. Lett.* **113**, 073901 (2014).
- [22] T. Morimoto and N. Nagaosa, Topological nature of nonlinear optical effects in solids, *Sci. Adv.* **2**, 2(5):e1501524 (2016).
- [23] M. Nakamura, S. Horiuchi, F. Kagawa, N. Ogawa, T. Kurumaji, Y. Tokura, and M. Kawasaki, Shift current photovoltaic effect in a ferroelectric charge-transfer complex, *Nat. Commun.* **8**, 281 (2017).
- [24] A. M. Cook, B. M. Fregoso, F. de Juan, S. Coh, and J. E. Moore, Design principles for shift current photovoltaics (2017).
- [25] B. M. Fregoso, T. Morimoto, and J. E. Moore, Quantitative relationship between polarization differences and the zone-averaged shift photocurrent, *Phys. Rev. B* **96**, 075421 (2017).
- [26] Y. J. Zhang, T. Ideue, M. Onga, F. Qin, R. Suzuki, A. Zak, R. Tenne, J. H. Smet, and Y. Iwasa, Enhanced intrinsic photovoltaic effect in tungsten disulfide nanotubes, *Nature* **570**, 349 (2019).
- [27] Y. Zhang, T. Holder, H. Ishizuka, F. de Juan, N. Nagaosa, C. Felser, and B. Yan, Switchable magnetic bulk photovoltaic effect in the two-dimensional magnet  $\text{CrI}_3$ , *Nat. Commun.* **10**, 3783 (2019).
- [28] H. Xu, H. Wang, J. Zhou, and J. Li, Pure spin photocurrent in non-centrosymmetric crystals: bulk spin photovoltaic effect, *Nat. Commun.* **12**, 4330 (2021).
- [29] T. Akamatsu, T. Ideue, L. Zhou, Y. Dong, S. Kitamura, M. Yoshii, D. Yang, M. Onga, Y. Nakagawa, K. Watanabe, T. Taniguchi, J. Laurienzo, J. Huang, Z. Ye, T. Morimoto, H. Yuan, and Y. Iwasa, A van der Waals interface that creates in-plane polarization and a spontaneous photovoltaic effect, *Science* **372**, 68 (2021).
- [30] A. M. Schankler, L. Gao, and A. M. Rappe, Large Bulk Piezophotovoltaic Effect of Monolayer  $2\text{H-MoS}_2$ , *J. Phys. Chem. Lett.* **12**, 1244 (2021).
- [31] T. Ideue and Y. Iwasa, Symmetry Breaking and Nonlinear Electric Transport in van der Waals Nanostructures, *Annu. Rev. Condens. Matter Phys.* **12**, 201 (2021).
- [32] K. S. Novoselov, D. Jiang, F. Schedin, T. J. Booth, V. V. Khotkevich, S. V. Morozov, and A. K. Geim, Two-dimensional atomic crystals, *Proc. Natl. Acad. Sci. USA* **102**, 10451 (2005).
- [33] S. B. Desai, S. R. Madhvapathy, M. Amani, D. Kiriya, M. Hettick, M. Tosun, Y. Zhou, M. Dubey, J. W. Ager III, D. Chrzan, and A. Javey, Gold-Mediated Exfoliation of Ultralarge Optoelectronically-Perfect Monolayers, *Adv. Mater.* **28**, 4053 (2016).
- [34] Z. Lin, A. McCreary, N. Briggs, S. Subramanian, K. Zhang, Y. Sun, X. Li, N. J. Borys, H. Yuan, S. K. Fullerton-Shirey, A. Chernikov, H. Zhao, S. McDonnell, A. M. Lindenberg, K. Xiao, B. J. LeRoy, M. Drndic, J. C. M. Hwang, J. Park, M. Chhowalla, R. E. Schaak, A. Javey, M. C. Hersam, J. Robinson, and M. Terrones, 2D materials advances: from large scale synthesis and controlled heterostructures to improved characterization techniques, defects and applications, *2D Mater.* **3**, 042001 (2016).
- [35] J. Yu, X. Hu, H. Li, X. Zhou, and T. Zhai, Large-scale synthesis of 2D metal dichalcogenides, *J. Mater. Chem. C* **6**, 4627 (2018).
- [36] S. Wang, J.-K. Huang, M. Li, A. Azam, X. Zu, L. Qiao, J. Yang, and S. Li, Growth of High-Quality Monolayer Transition Metal Dichalcogenide Nanocrystals by Chemical Vapor Deposition and Their Photoluminescence and Electrocatalytic Properties, *ACS Appl. Mater. Interfaces* **13**, 47962 (2021).
- [37] T. K. Fryett, A. Zhan, and A. Majumdar, Phase-matched nonlinear optics via patterning layered materials, *Opt. Lett.* **42**, 3586 (2017).
- [38] J. He, D. Wei, and X. Wang, Quasi-phase matching for a nonlinear photonic waveguide enabled by monolayer transition-metal dichalcogenide arrays, *J. Korean Phys Soc* **79**, 380 (2021).
- [39] R. Fei, X. Lu, and L. Yang, Intrinsic Spin Photogalvanic Effect in Nonmagnetic Insulator, arXiv:2006.10690 (2020).
- [40] M. Bieler, K. Pierz, and U. Siegner, Simultaneous generation of shift and injection currents in (110)-grown GaAs/AlGaAs quantum wells, *J. Appl. Phys.* **100**, 083710 (2006).
- [41] B. M. Fregoso, Bulk photovoltaic effects in the presence of a static electric field, *Phys. Rev. B* **100**, 064301 (2019).
- [42] Y. Ikeda, S. Kitamura, and T. Morimoto, Floquet engineering of electric polarization with two-frequency drive, *Prog. Theor. Exp. Phys.* **2022**, 04A101 (2022).
- [43] K. M. Dorney, T. Fan, Q. L. D. Nguyen, J. L. Ellis, D. D. Hickstein, N. Brooks, D. Zusin, C. Gentry, C. Hernández-García, H. C. Kapteyn, and M. M. Murnane, Bright, single helicity, high harmonics driven by mid-infrared bicircular laser fields, *Opt. Express* **29**, 38119 (2021).
- [44] T. V. Trevisan, P. V. Arribi, O. Heinonen, R.-J. Slager, and P. P. Orth, Bicircular Light Floquet Engineering of Magnetic Symmetry and Topology and Its Application to the Dirac Semimetal  $\text{Cd}_3\text{As}_2$ , *Phys. Rev. Lett.* **128**, 066602 (2022).
- [45] A. Jiménez-Galán, R. E. F. Silva, O. Smirnova, and M. Ivanov, Lightwave control of topological properties in 2D materials for sub-cycle and non-resonant valley manipulation, *Nat. Photonics* **14**, 728 (2020).
- [46] S. Odžak and D. B. Milošević, Bicircular-laser-field-assisted electron-ion radiative recombination, *Phys. Rev. A* **92**, 053416 (2015).
- [47] E. Pisanty, S. Sukiasyan, and M. Ivanov, Spin conservation in high-order-harmonic generation using bicircular fields, *Phys. Rev. A* **90**, 043829 (2014).
- [48] X. Xi, L. Zhao, Z. Wang, H. Berger, L. Forró, J. Shan, and K. F. Mak, Strongly enhanced charge-density-wave order in monolayer  $\text{NbSe}_2$ , *Nat. Nanotech.* **10**, 765 (2015).
- [49] U. Chatterjee, J. Zhao, M. Iavarone, R. Di Capua, J. P. Castellán, G. Karapetrov, C. D. Malliakas, M. G. Kanatzidis, H. Claus, J. P. C. Ruff, F. Weber, J. van Wezel, J. C. Campuzano, R. Osborn, M. Randeria, N. Trivedi, M. R. Norman, and S. Rosenkranz, Emergence of coherence in the charge-density wave state of  $2\text{H-NbSe}_2$ , *Nat. Commun.* **6**, 6313 (2015).
- [50] J. A. Wilson, F. J. Di Salvo, and S. Mahajan, Charge-density waves and superlattices in the metallic layered transition metal dichalcogenides, *Adv. Phys.* **50**, 1171 (2001).
- [51] S. Kim and Y.-W. Son, Quasiparticle energy bands and Fermi surfaces of monolayer  $\text{NbSe}_2$ , *Phys. Rev. B* **96**, 155439 (2017).
- [52] W.-Y. He, B. T. Zhou, J. J. He, N. F. Q. Yuan, T. Zhang, and K. T. Law, Magnetic field driven nodal topological superconductivity in monolayer transition metal dichalcogenides, *Commun. Phys.* **1**, 40 (2018).
- [53] X. Xi, Z. Wang, W. Zhao, J.-H. Park, K. T. Law, H. Berger, L. Forró, J. Shan, and K. F. Mak, Ising pairing in superconducting  $\text{NbSe}_2$  atomic layers, *Nat. Phys.* **12**, 139 (2016).

- [54] E. Sohn, X. Xi, W.-Y. He, S. Jiang, Z. Wang, K. Kang, J.-H. Park, H. Berger, L. Forró, K. T. Law, J. Shan, and K. F. Mak, An unusual continuous paramagnetic-limited superconducting phase transition in 2D NbSe<sub>2</sub>, *Nat. Mater.* **17**, 504 (2018).
- [55] A. Anikin, R. D. Schaller, G. P. Wiederrecht, E. R. Margine, I. I. Mazin, and G. Karapetrov, Ultrafast dynamics in the high-symmetry and in the charge density wave phase of 2H-NbSe<sub>2</sub>, *Phys. Rev. B* **102**, 205139 (2020).
- [56] C.-S. Lian, C. Si, J. Wu, and W. Duan, First-principles study of Na-intercalated bilayer NbSe<sub>2</sub>: Suppressed charge-density wave and strain-enhanced superconductivity, *Phys. Rev. B* **96**, 235426 (2017).
- [57] J. M. Lu, O. Zheliuk, I. Leermakers, N. F. Q. Yuan, U. Zeitler, K. T. Law, and J. T. Ye, Evidence for two-dimensional Ising superconductivity in gated MoS<sub>2</sub>, *Science* **350**, 1353 (2015).
- [58] Y. Saito, Y. Nakamura, M. S. Bahramy, Y. Kohama, J. Ye, Y. Kasahara, Y. Nakagawa, M. Onga, M. Tokunaga, T. Nojima, Y. Yanase, and Y. Iwasa, Superconductivity protected by spin-valley locking in ion-gated MoS<sub>2</sub>, *Nat. Phys.* **12**, 144 (2016).
- [59] B. T. Zhou, N. F. Q. Yuan, H.-L. Jiang, and K. T. Law, Ising superconductivity and Majorana fermions in transition-metal dichalcogenides, *Phys. Rev. B* **93**, 180501(R) (2016).
- [60] L. Bawden, S. P. Cooil, F. Mazzola, J. M. Riley, L. J. Collins-McIntyre, V. Sunko, K. W. B. Hunvik, M. Leandersson, C. M. Polley, T. Balasubramanian, T. K. Kim, M. Hoesch, J. W. Wells, G. Balakrishnan, M. S. Bahramy, and P. D. C. King, Spinvalley locking in the normal state of a transition-metal dichalcogenide superconductor, *Nat. Commun.* **7**, 11711 (2016).
- [61] R. Habara and K. Wakabayashi, Optically induced spin current in monolayer NbSe<sub>2</sub>, *Phys. Rev. B* **103**, L161410 (2021).
- [62] R. Habara and K. Wakabayashi, Nonlinear optical hall effect of few-layered nbse<sub>2</sub>, *Phys. Rev. Research* **4**, 013219 (2022).
- [63] See Supplementary Material at [URL will be inserted by publisher] for imaginary parts of NLO conductivities under irradiation of BCL, rotational angle dependences of BCL on NLO conductivities, derivation of shift- and injection-current conductivities, and NLO conductivity for TMDC semiconductor.
- [64] G.-B. Liu, W.-Y. Shan, Y. Yao, W. Yao, and D. Xiao, Three-band tight-binding model for monolayers of group-VIB transition metal dichalcogenides, *Phys. Rev. B* **88**, 085433 (2013).
- [65] S. Kim and Y.-W. Son, Dichotomy of saddle points in energy bands of monolayer NbSe<sub>2</sub>, *Phys. Rev. B* **104**, 045426 (2021).
- [66] N. L. Kang and S. D. Choi, Derivation of nonlinear optical conductivity by using a reduction identity and a state-dependent projection method, *J. Phys. A Math. Theor.* **43**, 165203 (2010).
- [67] H. J. Lee, N. L. Kang, J. Y. Sug, and S. D. Choi, Calculation of the nonlinear optical conductivity by a quantum-statistical method, *Phys. Rev. B* **65**, 195113 (2002).
- [68] N. L. Kang, S.-S. Lee, and S. D. Choi, Projection-reduction method applied to deriving non-linear optical conductivity for an electron-impurity system, *AIP Adv.* **3**, 072104 (2013).
- [69] C. Aversa and J. E. Sipe, Nonlinear optical susceptibilities of semiconductors: Results with a length-gauge analysis, *Phys. Rev. B* **52**, 14636 (1995).
- [70] J. E. Sipe and E. Ghahramani, Nonlinear optical response of semiconductors in the independent-particle approximation, *Phys. Rev. B* **48**, 11705 (1993).
- [71] A. Taghizadeh, F. Hipolito, and T. G. Pedersen, Linear and nonlinear optical response of crystals using length and velocity gauges: Effect of basis truncation, *Phys. Rev. B* **96**, 195413 (2017).
- [72] Q. Y. Lu, N. Bandyopadhyay, S. Slivken, Y. Bai, and M. Razeghi, Room temperature single-mode terahertz sources based on intracavity difference-frequency generation in quantum cascade lasers, *Appl. Phys. Lett.* **99**, 131106 (2011).
- [73] R. Axel, G. Alessio, H. Ingmar, E. F. Martin, S. E. E. Kjeld, and M. Marco, Widely-tunable mid-infrared frequency comb source based on difference frequency generation, *Opt. Lett.* **37**, 2232 (2012).
- [74] F. Mauger, A. D. Bandrauk, and T. Uzer, Circularly polarized molecular high harmonic generation using a bicircular laser, *J. PHYS B-AT MOL OPT* **49**, 10LT01 (2016).
- [75] Z.-Y. Chen, Spectral control of high harmonics from relativistic plasmas using bicircular fields, *Phys. Rev. E* **97**, 043202 (2018).
- [76] A. Gazibegović-Busuladžić, W. Becker, and D. B. Milošević, Helicity asymmetry in strong-field ionization of atoms by a bicircular laser field, *Opt. Express* **26**, 12684 (2018).
- [77] R. D. King-Smith and D. Vanderbilt, Theory of polarization of crystalline solids, *Phys. Rev. B* **47**, 1651 (1993).
- [78] R. Resta, Macroscopic polarization in crystalline dielectrics: the geometric phase approach, *Rev. Mod. Phys.* **66**, 899 (1994).
- [79] N. Marzari, A. A. Mostofi, J. R. Yates, I. Souza, and D. Vanderbilt, Maximally localized wannier functions: Theory and applications, *Rev. Mod. Phys.* **84**, 1419 (2012).
- [80] H. Watanabe and Y. Yanase, Chiral photocurrent in parity-violating magnet and enhanced response in topological antiferromagnet, *Phys. Rev. X* **11**, 011001 (2021).
- [81] Q. Ma, R. Krishna Kumar, S.-Y. Xu, F. H. L. Koppens, and J. C. W. Song, Photocurrent as a multiphysics diagnostic of quantum materials, *Nat. Rev. Phys.* 10.1038/s42254-022-00551-2 (2023).